

N-Channel Enhancement Mode MOSFET

Features

- 80V/100A
 $R_{DS(ON)} = 6.6m\Omega$ (typ.) @ $V_{GS} = 10V$
- Avalanche Rated
- Reliable and Rugged
- Lead Free and Green Devices Available (RoHS Compliant)

Pin Description

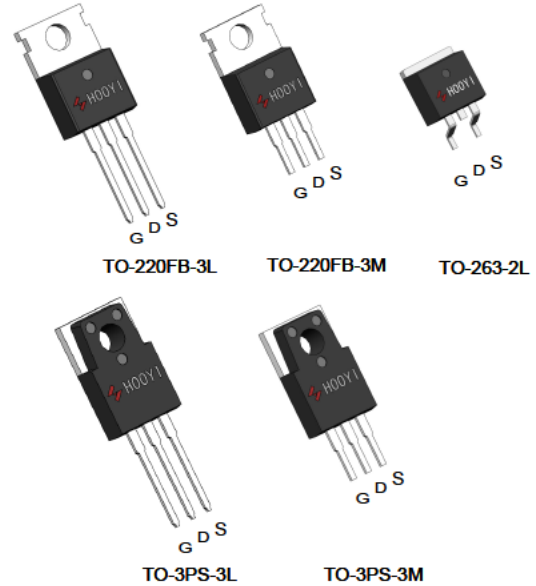



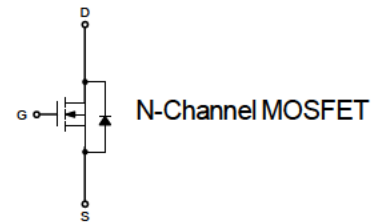

Applications

- Power Management for Inverter Systems.



Ordering and Marking Information

 P HY3008 YǝXXJWW G	 M HY3008 YǝXXJWW G	 B HY3008 YǝXXJWW G	Package Code P : TO-220FB-3L M : TO-220FB-3M B: TO-263-2L PS: TO-3PS-3L PM: TO-3PS-3M
 PS HY3008 YǝXXJWW G	 PM HY3008 YǝXXJWW G		Date Code Assembly Material YYXXX WW G : Lead Free Device

Note: HOOYI lead-free products contain molding compounds/die attach materials and 100% matte tin plate termination finish; which are fully compliant with RoHS. HOOYI lead-free products meet or exceed the lead-free requirements of IPC/JEDEC J-STD-020D for MSL classification at lead-free peak reflow temperature. HOOYI defines "Green" to mean lead-free (RoHS compliant) and halogen free (Br or Cl does not exceed 900ppm by weight in homogeneous material and total of Br and Cl does not exceed 1500ppm by weight).

HOOYI reserves the right to make changes to improve reliability or manufacturability without notice, and advise customers to obtain the latest version of relevant information to verify before placing orders.

Absolute Maximum Ratings

Symbol	Parameter	Rating	Unit
Common Ratings ($T_C=25^\circ\text{C}$ Unless Otherwise Noted)			
V_{DSS}	Drain-Source Voltage	80	V
V_{GSS}	Gate-Source Voltage	± 25	
T_J	Maximum Junction Temperature	175	$^\circ\text{C}$
T_{STG}	Storage Temperature Range	55 to 175	$^\circ\text{C}$
I_S	Diode Continuous Forward Current	$T_C=25^\circ\text{C}$	100 A
Mounted on Large Heat Sink			
I_{DM}	Pulsed Drain Current *		400** A
I_D	Continuous Drain Current	$T_C=25^\circ\text{C}$	100 A
		$T_C=100^\circ\text{C}$	70
P_D	Maximum Power Dissipation	$T_C=25^\circ\text{C}$	200 W
		$T_C=100^\circ\text{C}$	100
$R_{\theta JC}$	Thermal Resistance-Junction to Case	0.75	$^\circ\text{C}/\text{W}$
$R_{\theta JA}$	Thermal Resistance-Junction to Ambient	62.5	
Avalanche Ratings			
E_{AS}	Avalanche Energy, Single Pulsed	$L=0.5\text{mH}$	530*** mJ

Note : * Repetitive rating ; pulse width limited by junction temperature

** Drain current is limited by junction temperature

*** $V_D=64\text{V}$

Electrical Characteristics ($T_C = 25^\circ\text{C}$ Unless Otherwise Noted)

Symbol	Parameter	Test Conditions	HY3008			Unit
			Min.	Typ.	Max.	
Static Characteristics						
BV_{DSS}	Drain-Source Breakdown Voltage	$V_{GS}=0\text{V}, I_{DS}=250\mu\text{A}$	80	-	-	V
I_{DSS}	Zero Gate Voltage Drain Current	$V_{DS}=80\text{V}, V_{GS}=0\text{V}$ $T_J=85^\circ\text{C}$	-	-	1	μA
			-	-	10	
$V_{GS(th)}$	Gate Threshold Voltage	$V_{DS}=V_{GS}, I_{DS}=250\mu\text{A}$	2	3	4	V
I_{GSS}	Gate Leakage Current	$V_{GS}=\pm 25\text{V}, V_{DS}=0\text{V}$	-	-	± 100	nA
$R_{DS(ON)*}$	Drain-Source On-state Resistance	$V_{GS}=10\text{V}, I_{DS}=50\text{A}$	-	6.6	8.5	$\text{m}\Omega$
Diode Characteristics						
V_{SD}^*	Diode Forward Voltage	$I_{SD}=50\text{A}, V_{GS}=0\text{V}$	-	0.8	1	V
t_{rr}	Reverse Recovery Time	$I_{SD}=50\text{A}, dI_{SD}/dt=100\text{A}/\mu\text{s}$	-	62	-	ns
Q_{rr}	Reverse Recovery Charge		-	127	-	nC

Electrical Characteristics (Cont.) ($T_c = 25^\circ\text{C}$ Unless Otherwise Noted)

Symbol	Parameter	Test Conditions	HY3008			Unit
			Min.	Typ.	Max.	
Dynamic Characteristics						
R_G	Gate Resistance	$V_{GS}=0V, V_{DS}=0V, F=1\text{MHz}$	-	1.0	-	Ω
C_{iss}	Input Capacitance	$V_{GS}=0V,$ $V_{DS}=25V,$ Frequency=1.0MHz	-	3150	-	pF
C_{oss}	Output Capacitance		-	440	-	
C_{rss}	Reverse Transfer Capacitance		-	199	-	
$t_{d(ON)}$	Turn-on Delay Time	$V_{DD}=40V, R_G = 5 \Omega,$ $I_{DS} = 50A, V_{GS}=10V,$	-	23	-	ns
T_r	Turn-on Rise Time		-	39	-	
$t_{d(OFF)}$	Turn-off Delay Time		-	55	-	
T_f	Turn-off Fall Time		-	33	-	
Gate Charge Characteristics						
Q_g	Total Gate Charge	$V_{DS}=64V, V_{GS}=10V,$ $I_{DS}=50A$	-	67	-	nC
Q_{gs}	Gate-Source Charge		-	14	-	
Q_{gd}	Gate-Drain Charge		-	22	-	

Note * : Pulse test ; pulse width $\leq 300\mu\text{s}$, duty cycle $\leq 2\%$.

Typical Operating Characteristics

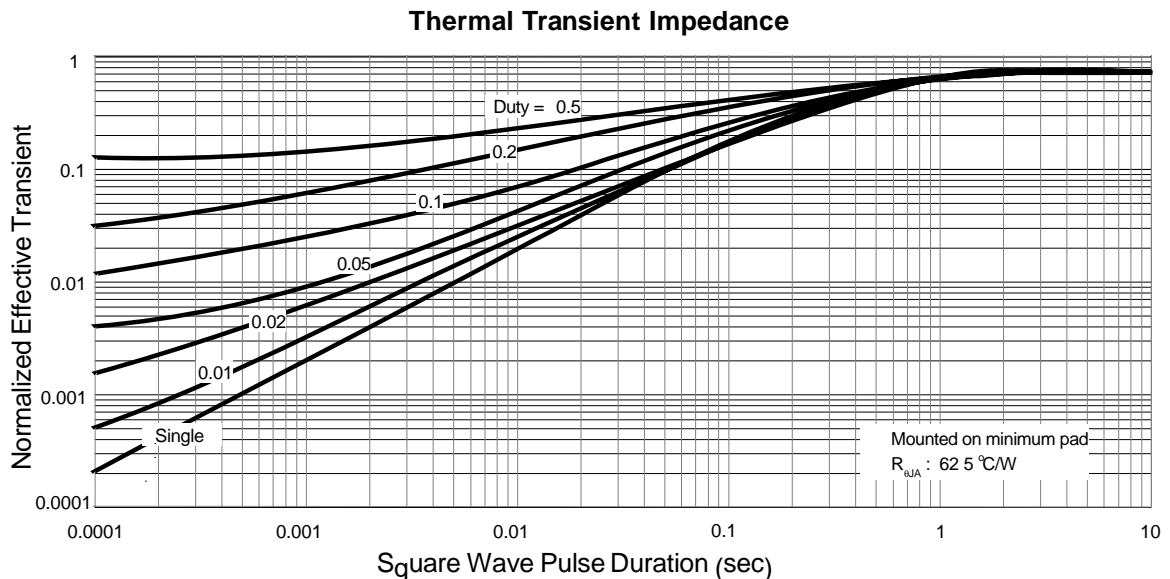
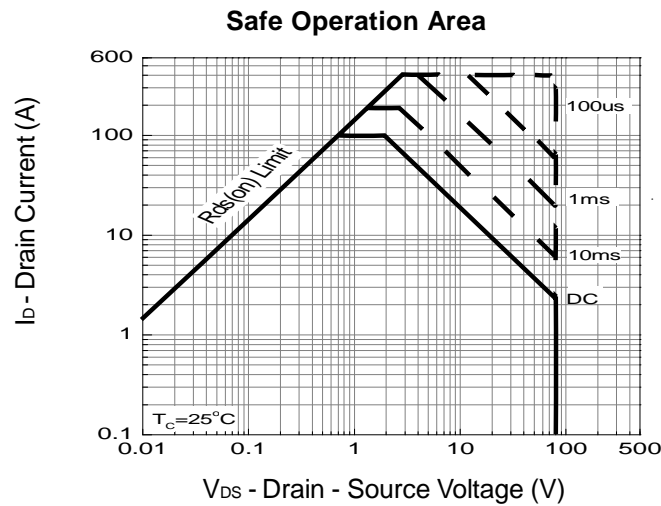
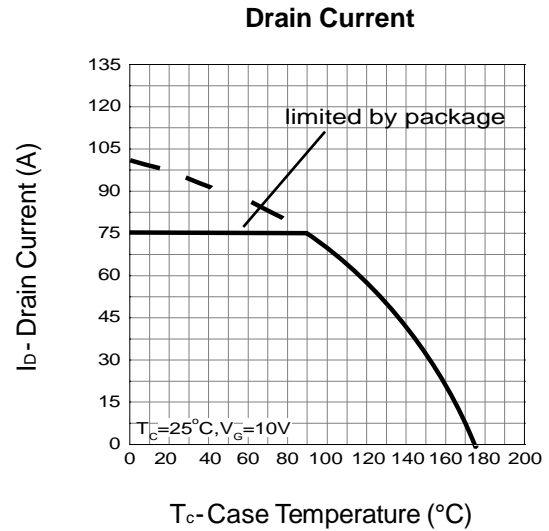
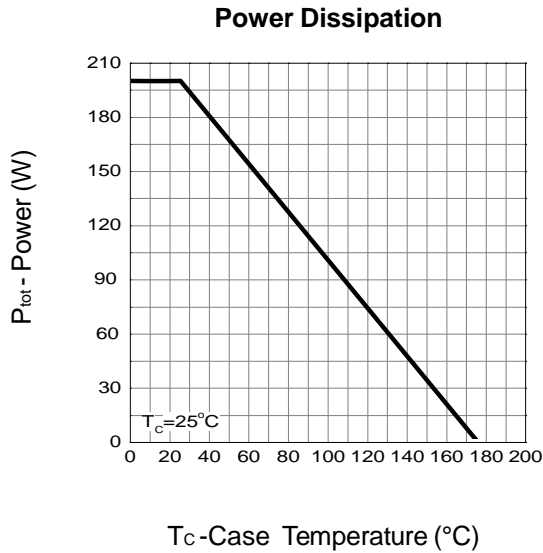

Typical Operating Characteristics (Cont.)

Output Characteristics

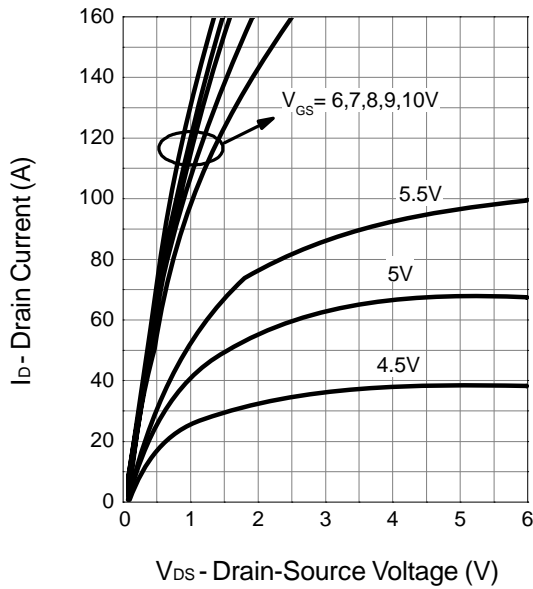

Drain-Source On Resistance

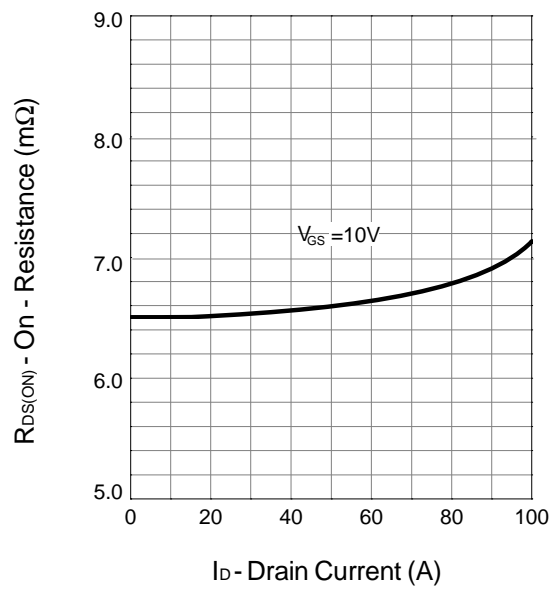

Drain-Source On Resistance

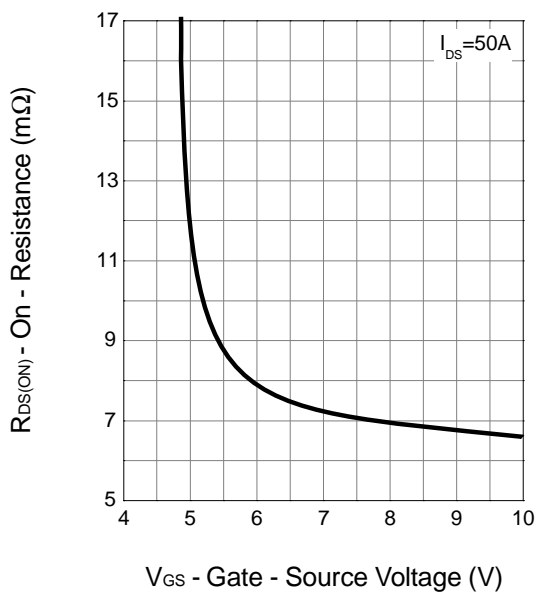

Gate Threshold Voltage

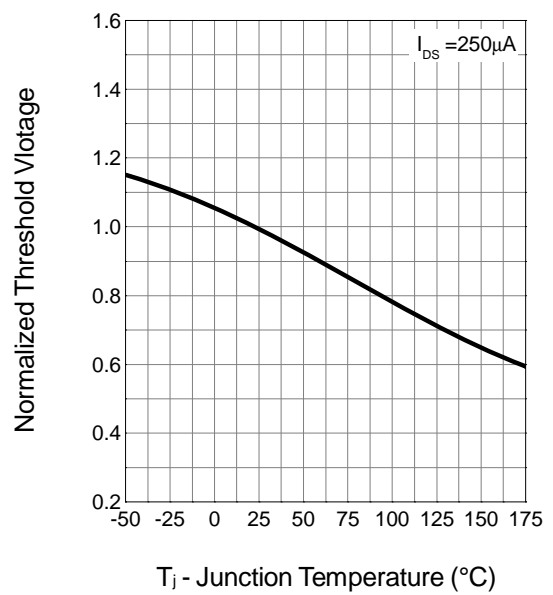

Typical Operating Characteristics (Cont.)

Drain-Source On Resistance

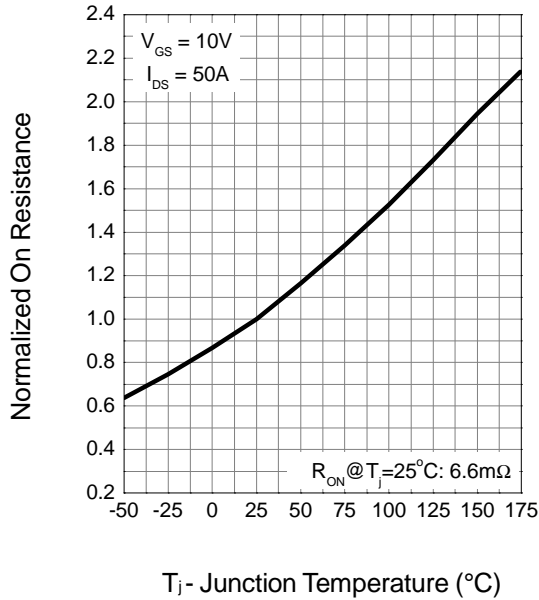

Source-Drain Diode Forward

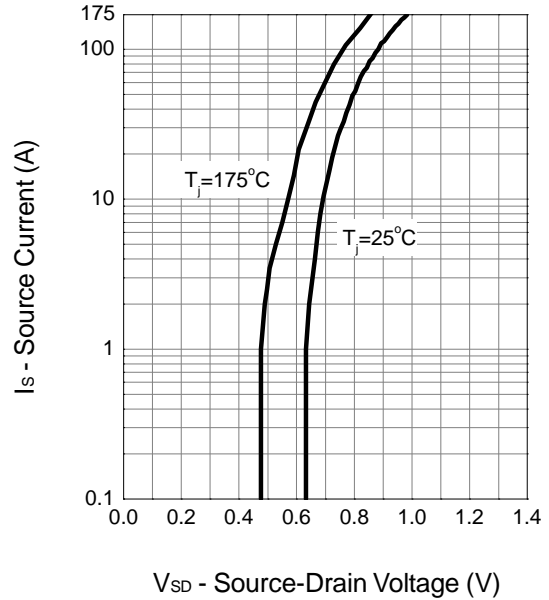

Capacitance

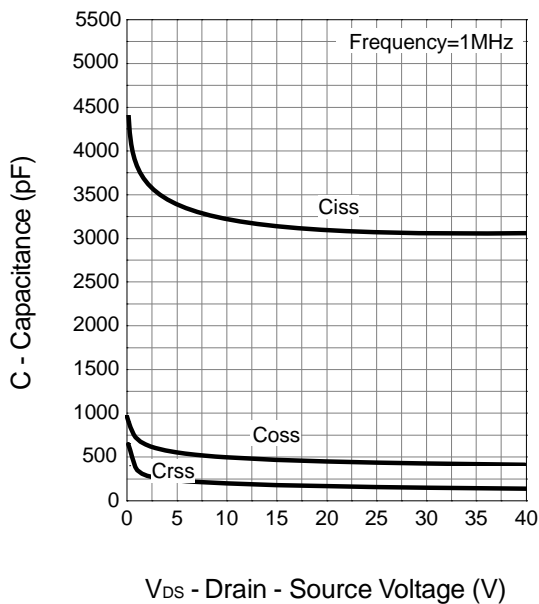

Gate Charge

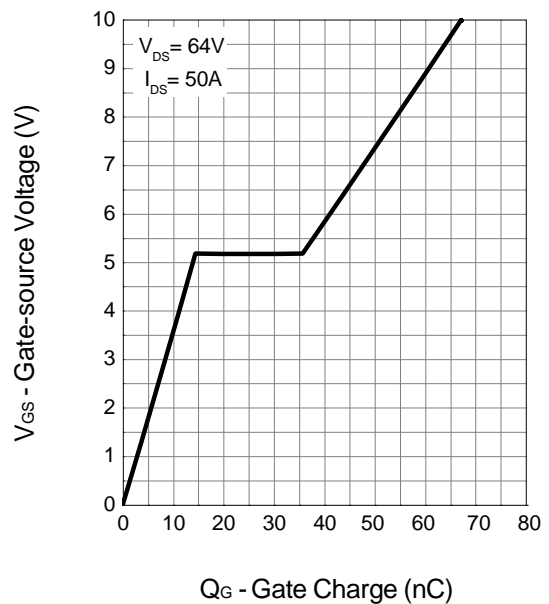

Avalanche Test Circuit and Waveforms

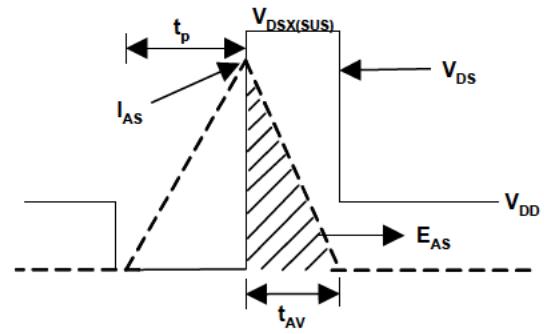
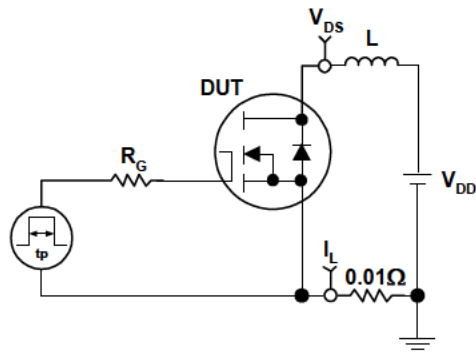

Avalanche Test Circuit and Waveforms

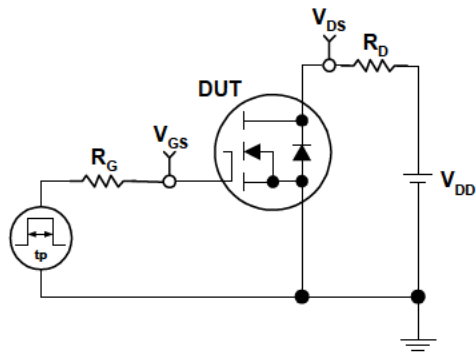

Package Information
TO-220FB-3L

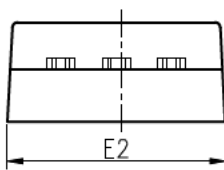
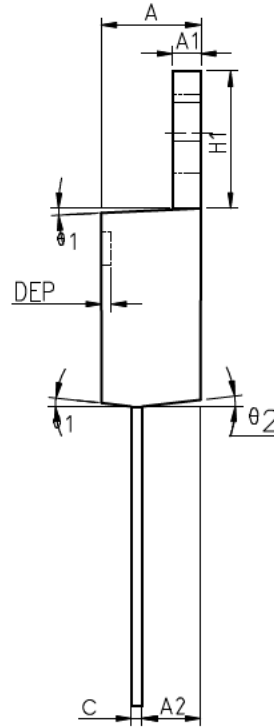
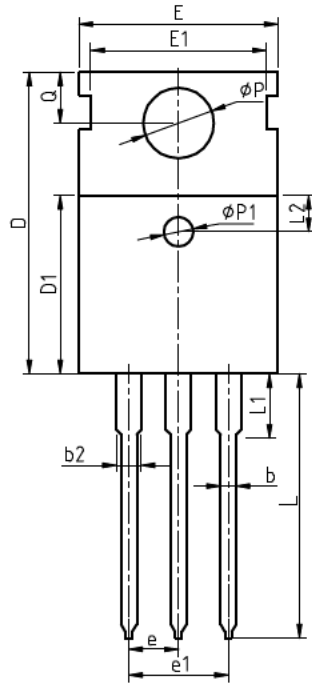

COMMON DIMENSIONS

SYMBOL	MIN	NOM	MAX	MIN	NOM	MAX
A	4.40	4.57	4.70	0.173	0.180	0.185
A1	1.27	1.30	1.33	0.050	0.051	0.052
A2	2.35	2.40	2.50	0.093	0.094	0.098
b	0.77	0.80	0.90	0.030	0.031	0.035
b2	1.17	1.27	1.36	0.046	0.050	0.054
c	0.48	0.50	0.56	0.019	0.020	0.022
D	15.40	15.60	15.80	0.606	0.614	0.622
D1	9.00	9.10	9.20	0.354	0.358	0.362
DEP	0.05	0.10	0.20	0.002	0.004	0.008
E	9.80	10.00	10.20	0.386	0.394	0.402
E1	-	8.70	-	-	0.343	-
E2	9.80	10.00	10.20	0.386	0.394	0.402
e		2.54	BSC		0.100	BSC
e1		5.08	BSC		0.200	BSC
H1	6.40	6.50	6.60	0.252	0.256	0.260
L	12.75	13.50	13.65	0.502	0.531	0.537
L1	-	3.10	3.30	-	0.122	0.130
L2		2.50	REF		0.098	REF
P	3.50	3.60	3.63	0.138	0.142	0.143
P1	3.50	3.60	3.63	0.138	0.142	0.143
Q	2.73	2.80	2.87	0.107	0.110	0.113
theta 1	5°	7°	9°	5°	7°	9°
theta 2	1°	3°	5°	1°	3°	5°
theta 3	1°	3°	5°	1°	3°	5°

TO-220FB-3M

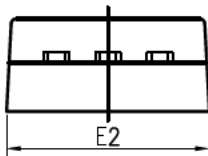
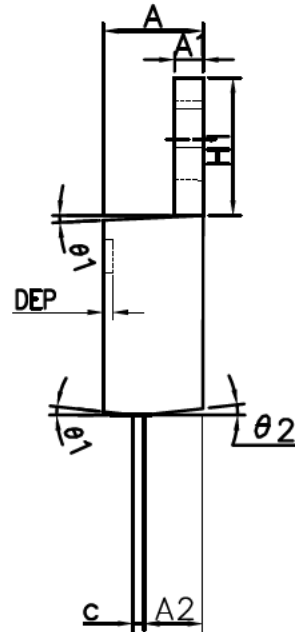
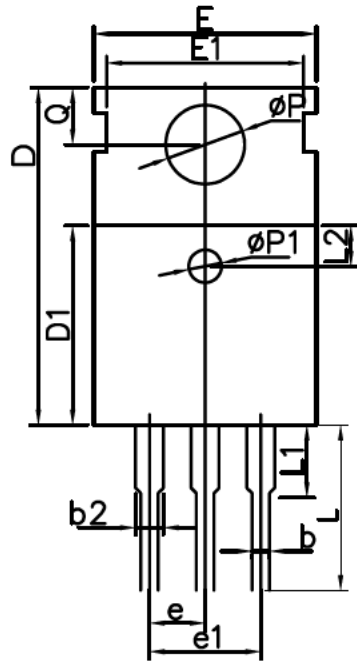

COMMON DIMENSIONS

SYMBOL	MIN	NOM	MAX	MIN	NOM	MAX
A	4.40	4.57	4.70	0.173	0.180	0.185
A1	1.27	1.30	1.33	0.050	0.051	0.052
A2	2.35	2.40	2.50	0.093	0.094	0.098
b	0.77	0.80	0.90	0.030	0.031	0.035
b2	1.17	1.27	1.36	0.046	0.050	0.054
c	0.48	0.50	0.56	0.019	0.020	0.022
D	15.40	15.60	15.80	0.606	0.614	0.622
D1	9.00	9.10	9.20	0.354	0.358	0.362
DEP	0.05	0.10	0.20	0.002	0.004	0.008
E	9.80	10.00	10.20	0.386	0.394	0.402
E1	-	8.70	-	-	0.343	-
E2	9.80	10.00	10.20	0.386	0.394	0.402
e		2.54	BSC		0.100	BSC
e1		5.08	BSC		0.200	BSC
H1	6.40	6.50	6.60	0.252	0.256	0.260
L	7.25	7.40	7.55	0.285	0.291	0.297
L1	-	3.10	3.30	-	0.122	0.130
L2		2.50	REF		0.098	REF
P	3.50	3.60	3.63	0.138	0.142	0.143
P1	3.50	3.60	3.63	0.138	0.142	0.143
Q	2.73	2.80	2.87	0.107	0.110	0.113
θ1	5°	7°	9°	5°	7°	9°
θ2	1°	3°	5°	1°	3°	5°

TO-263-2L

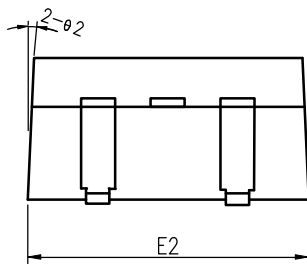
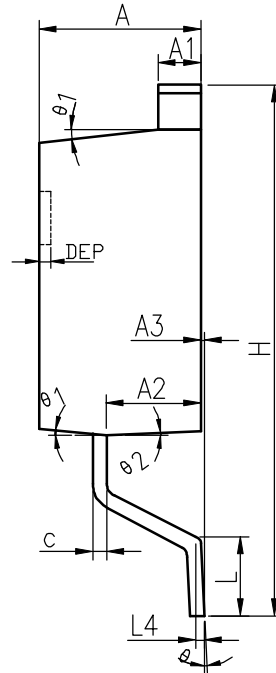
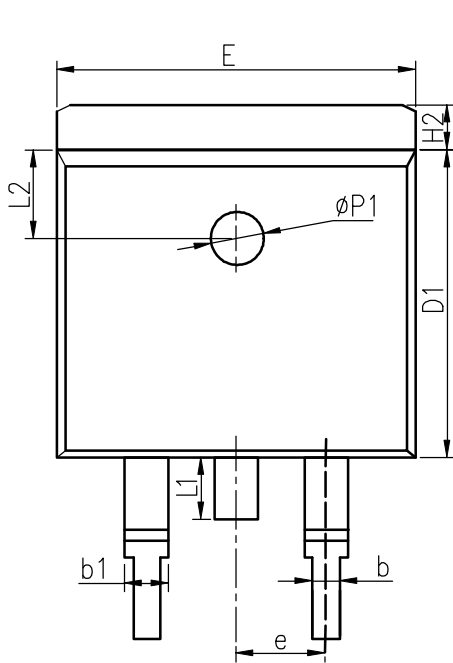

COMMON DIMENSIONS

SYMBOL	MM			INCH		
	MIN	NOM	MAX	MIN	NOM	MAX
A	4.40	4.57	4.70	0.173	0.180	0.185
A1	1.22	1.27	1.32	0.048	0.050	0.052
A2	2.59	2.69	2.79	0.102	0.106	0.110
A3	0.00	0.10	0.20	0.000	0.004	0.008
b	0.77	0.813	0.90	0.030	0.032	0.035
b1	1.20	1.270	1.36	0.047	0.050	0.054
c	0.34	0.381	0.47	0.013	0.015	0.019
D1	8.60	8.70	8.80	0.339	0.343	0.346
E	10.00	10.16	10.26	0.394	0.400	0.404
E2	10.00	10.10	10.20	0.394	0.398	0.402
e	2.54 BSC			0.100 BSC		
H	14.70	15.10	15.50	0.579	0.594	0.610
H2	1.17	1.27	1.40	0.046	0.050	0.055
L	2.00	2.30	2.60	0.079	0.091	0.102
L1	1.45	1.55	1.70	0.057	0.061	0.067
L2	2.50 REF			0.098 REF		
L4	0.25 BSC			0.010 BSC		
	0	5	8	0	5	8
1	5	7	9	5	7	9
2	1	3	5	1	3	5
ΦP1	1.40	1.50	1.60	0.055	0.059	0.063
DEP	0.05	0.10	0.20	0.002	0.004	0.008

TO-3PS-3L

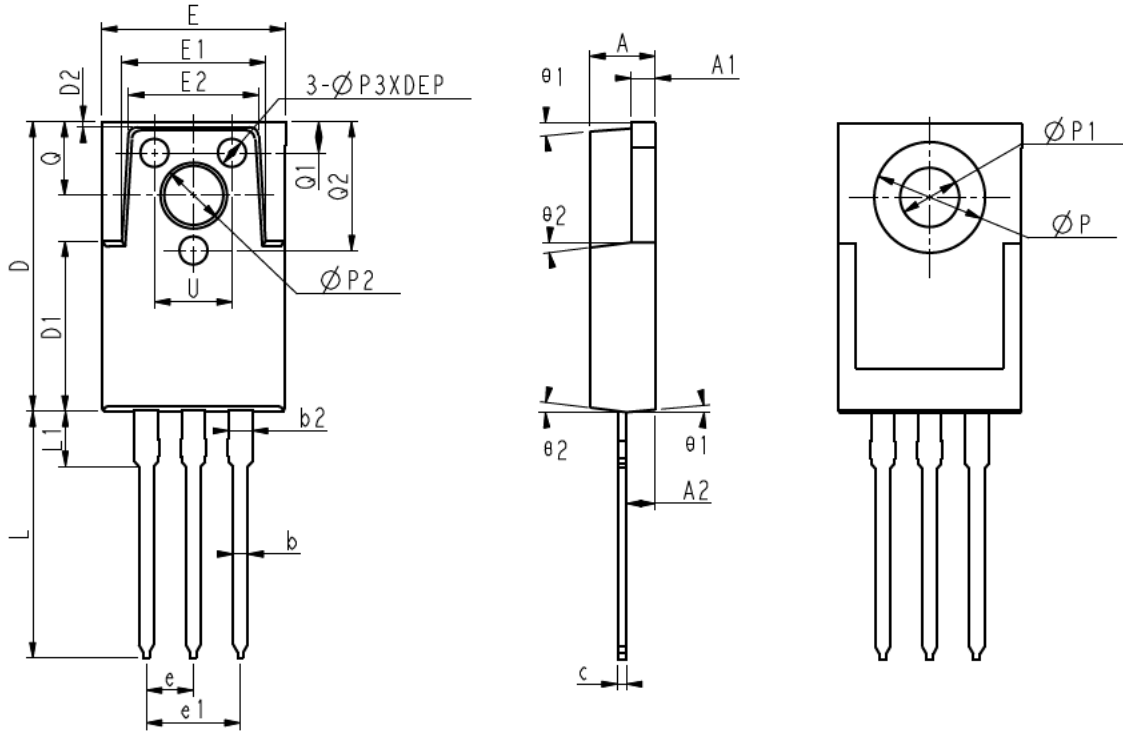

COMMON DIMENSIONS

SYMBOL	MIN	NOM	MAX
A	3.36	3.56	3.76
A1	1.27	1.30	1.37
A2	1.49	1.54	1.64
b	0.77	0.80	0.90
b2	1.17	1.27	1.36
c	0.48	0.50	0.56
D	15.50	15.70	15.90
D1	9.10	9.20	9.30
D2		0.30	REF
DEP	0.05	0.10	0.20
E	9.88	10.00	10.20
E1	7.80	8.00	8.20
E2	6.90	7.10	7.30
E3	9.90	10.00	10.10
e		2.54	BSC
e1		5.08	BSC
L	13.25	13.40	13.55
L1	-	3.00	3.30
P		6.00	REF
P1		3.20	REF
P2		3.57	REF
P3	1.40	1.50	1.60
Q	3.93	4.00	4.07
Q1	1.60	1.70	1.80
Q2	6.80	7.00	7.20
U	4.00	4.20	4.40
θ 1	3°	5°	7°
θ 2	5°	7°	9°
θ 3	1°	3°	5°

TO-3PS-3M

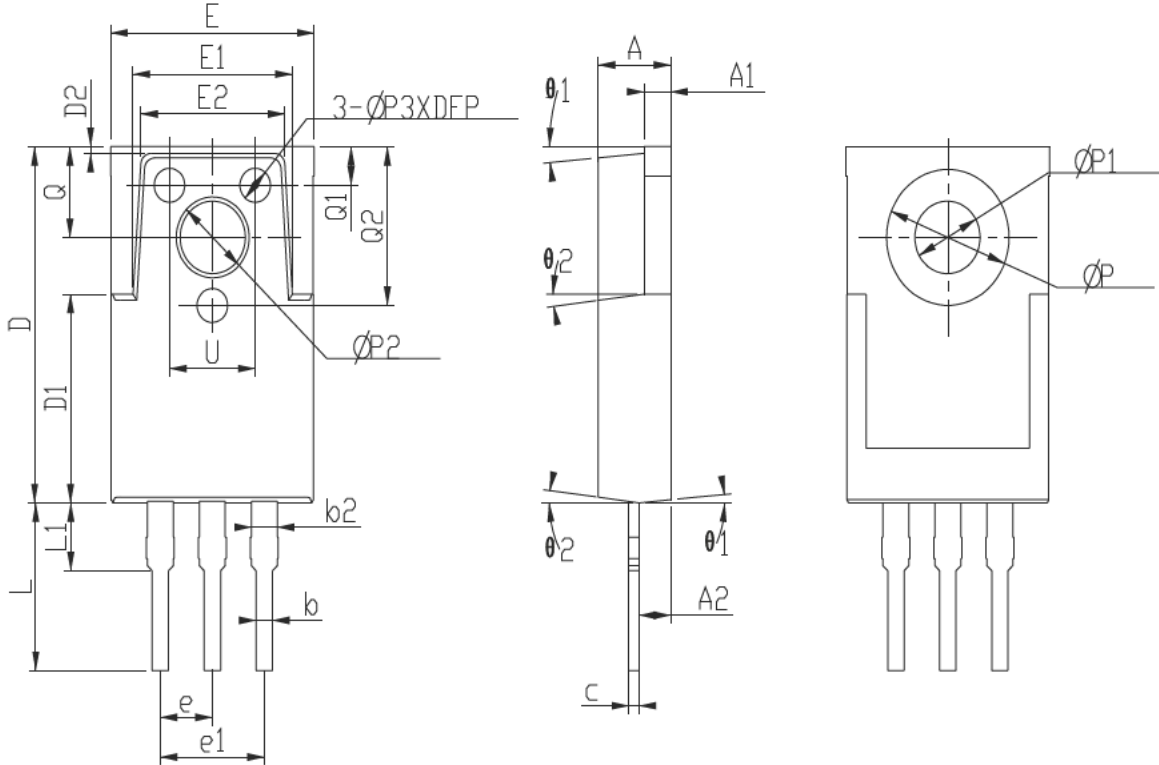

COMMON DIMENSIONS

SYMBOL	MIN	NOM	MAX
A	3.36	3.56	3.76
A1	1.27	1.30	1.37
A2	1.49	1.54	1.64
b	0.77	0.80	0.90
b2	1.17	1.27	1.36
c	0.48	0.50	0.56
D	15.50	15.70	15.90
D1	9.10	9.20	9.30
D2		0.30	REF
DEP	0.05	0.10	0.20
E	9.88	10.00	10.20
E1	7.80	8.00	8.20
E2	6.90	7.10	7.30
E3	9.90	10.00	10.10
e		2.54	BSC
e1		5.08	BSC
L	7.25	7.40	7.55
L1	-	3.00	3.30
P		6.00	REF
P1		3.20	REF
P2		3.57	REF
P3	1.40	1.50	1.60
Q	3.93	4.00	4.07
Q1	1.60	1.70	1.80
Q2	6.80	7.00	7.20
U	4.00	4.20	4.40
$\theta 1$	3°	5°	7°
$\theta 2$	5°	7°	9°
$\theta 3$	1°	3°	5°

Devices Per Unit

Package Type	Unit	Quantity
TO-220FB-3L	Tube	50
TO-220FB-3M	Tube	50
TO-263-2L	Tube	50
TO-3PS-3L	Tube	50
TO-3PS-3M	Tube	50

Classification Profile

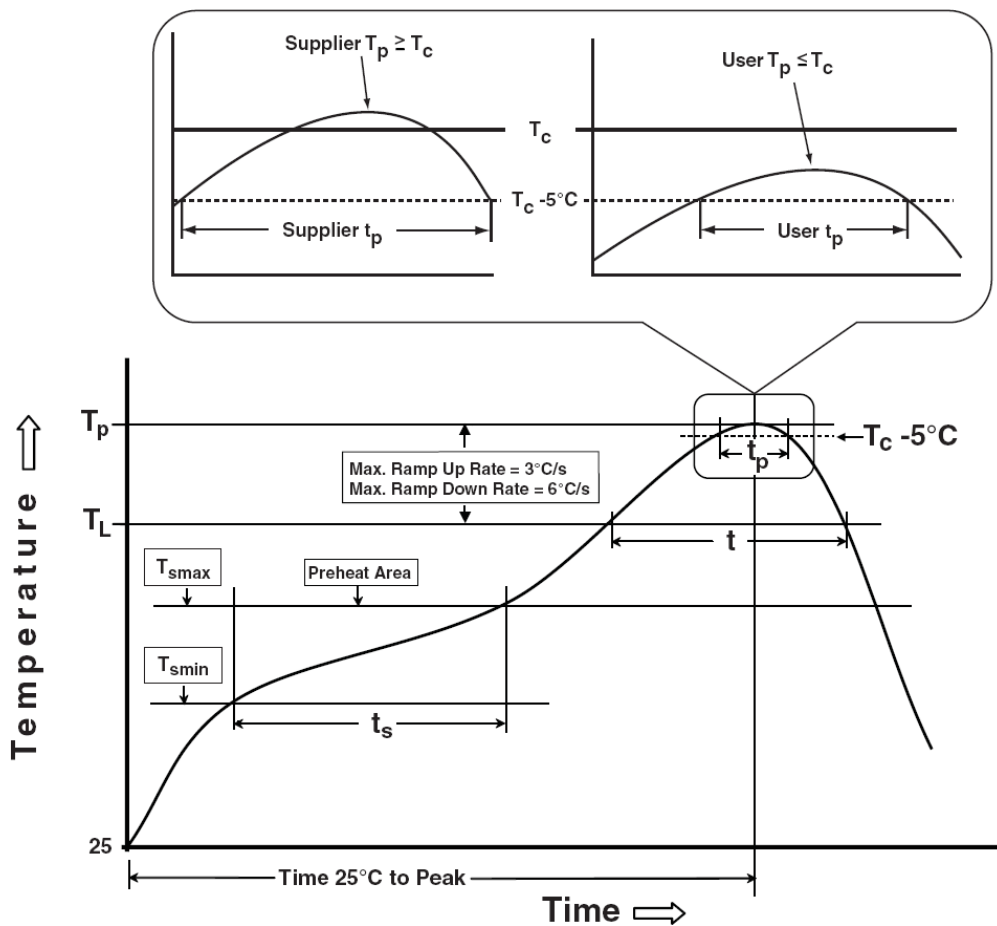

Classification Reflow Profiles

Profile Feature	Sn-Pb Eutectic Assembly	Pb-Free Assembly
Preheat & Soak		
Temperature min (T_{smin})	100 °C	150 °C
Temperature max (T_{smax})	150 °C	200 °C
Time (T_{smin} to T_{smax}) (t_s)	60-120 seconds	60-120 seconds
Average ramp-up rate (T_{smax} to T_p)	3 °C/second max.	3°C/second max.
Liquidous temperature (T_L)	183 °C	217 °C
Time at liquidous (t_L)	60-150 seconds	60-150 seconds
Peak package body Temperature (T_p)*	See Classification Temp in table 1	See Classification Temp in table 2
Time (t_p)** within 5°C of the specified classification temperature (T_c)	20** seconds	30** seconds
Average ramp-down rate (T_p to T_{smax})	6 °C/second max.	6 °C/second max.
Time 25°C to peak temperature	6 minutes max.	8 minutes max.
* Tolerance for peak profile Temperature (T_p) is defined as a supplier minimum and a user maximum.		
** Tolerance for time at peak profile temperature (t_p) is defined as a supplier minimum and a user maximum.		

Table 1. SnPb Eutectic Process – Classification Temperatures (T_c)

Package Thickness	Volume mm ³ <350	Volume mm ³ ≥350
<2.5 mm	235 °C	220 °C
≥2.5 mm	220 °C	220 °C

Table 2. Pb-free Process – Classification Temperatures (T_c)

Package Thickness	Volume mm ³ <350	Volume mm ³ 350-2000	Volume mm ³ >2000
<1.6 mm	260 °C	260 °C	260 °C
1.6 mm – 2.5 mm	260 °C	250 °C	245 °C
≥2.5 mm	250 °C	245 °C	245 °C

Reliability Test Program

Test item	Method	Description
SOLDERABILITY	JESD-22, B102	5 Sec, 245°C
HOLT	JESD-22, A108	1000 Hrs, Bias @ 125°C
PCT	JESD-22, A102	168 Hrs, 100%RH, 2atm, 121°C
TCT	JESD-22, A104	500 Cycles, -65°C~150°C