

N-Channel Enhancement Mode MOSFET

Features

- 40V/208A
 $R_{DS(ON)} = 2.4 \text{ m}\Omega \text{ (typ.) @ } V_{GS} = 10\text{V}$
- 100% avalanche tested
- Reliable and Rugged
- Lead Free and Green Devices Available (RoHS Compliant)

Pin Description



TO-247-3L

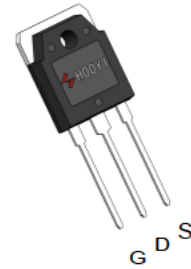



TO-3P-3L

Applications

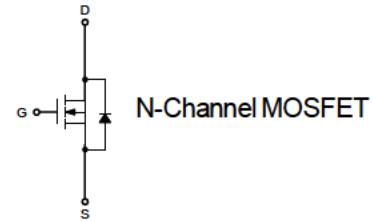
- Power Management for Inverter Systems.



Ordering and Marking Information

 W HY4004 YYXXJWW G	 A HY4004 YYXXJWW G	Package Code W : TO-247-3L A : TO-3P-3L
Date Code YYXX WW		Assembly Material G : Lead Free Device

Note: HOOYI lead-free products contain molding compounds/die attach materials and 100% matte tin plate termination finish; which are fully compliant with RoHS. HOOYI lead-free products meet or exceed the lead-free requirements of IPC/JEDEC J-STD-020D for MSL classification at lead-free peak reflow temperature. HOOYI defines "Green" to mean lead-free (RoHS compliant) and halogen free (Br or Cl does not exceed 900ppm by weight in homogeneous material and total of Br and Cl does not exceed 1500ppm by weight).

HOOYI reserves the right to make changes to improve reliability or manufacturability without notice, and advise customers to obtain the latest version of relevant information to verify before placing orders.

Absolute Maximum Ratings

Symbol	Parameter		Rating	Unit
Common Ratings ($T_C=25^\circ\text{C}$ Unless Otherwise Noted)				
V_{DSS}	Drain-Source Voltage		40	V
V_{GSS}	Gate-Source Voltage		± 20	
T_J	Maximum Junction Temperature		175	$^\circ\text{C}$
T_{STG}	Storage Temperature Range		-55 to 175	$^\circ\text{C}$
I_S	Diode Continuous Forward Current	$T_C=25^\circ\text{C}$	208	A
Mounted on Large Heat Sink				
I_{DM}	Pulsed Drain Current *	$T_C=25^\circ\text{C}$	750**	A
I_D	Continuous Drain Current	$T_C=25^\circ\text{C}$	208	A
		$T_C=100^\circ\text{C}$	138	
P_D	Maximum Power Dissipation	$T_C=25^\circ\text{C}$	268	W
		$T_C=100^\circ\text{C}$	125	
$R_{\theta JC}$	Thermal Resistance-Junction to Case		0.56	$^\circ\text{C/W}$
$R_{\theta JA}$	Thermal Resistance-Junction to Ambient		40	
Avalanche Ratings				
E_{AS}	Avalanche Energy, Single Pulsed	$L=0.5\text{mH}$	1.4***	J

Note : * Repetitive rating ; pulse width limited by junction temperature

** Drain current is limited by junction temperature

*** $V_D=32\text{V}$

Electrical Characteristics ($T_C = 25^\circ\text{C}$ Unless Otherwise Noted)

Symbol	Parameter	Test Conditions	HY4004			Unit
			Min.	Typ.	Max.	
Static Characteristics						
BV_{DSS}	Drain-Source Breakdown Voltage	$V_{GS}=0\text{V}, I_{DS}=250\mu\text{A}$	40	-	-	V
I_{DSS}	Zero Gate Voltage Drain Current	$V_{DS}=40\text{V}, V_{GS}=0\text{V}$ $T_J=85^\circ\text{C}$	-	-	1	μA
			-	-	10	
$V_{GS(th)}$	Gate Threshold Voltage	$V_{DS}=V_{GS}, I_{DS}=250\mu\text{A}$	2.0	3.0	4.0	V
I_{GSS}	Gate Leakage Current	$V_{GS}=\pm 20\text{V}, V_{DS}=0\text{V}$	-	-	± 100	nA
$R_{DS(ON)*}$	Drain-Source On-state Resistance	$V_{GS}=10\text{V}, I_{DS}=104\text{A}$	-	2.4	3.0	$\text{m}\Omega$
Diode Characteristics						
V_{SD}^*	Diode Forward Voltage	$I_{SD}=104\text{A}, V_{GS}=0\text{V}$	-	0.8	1.2	V
t_{rr}	Reverse Recovery Time	$I_{SD}=104\text{A},$ $di_{SD}/dt=100\text{A}/\mu\text{s}$	-	36	-	ns
Q_{rr}	Reverse Recovery Charge		-	58	-	nC

Electrical Characteristics (Cont.) ($T_c = 25^\circ\text{C}$ Unless Otherwise Noted)

Symbol	Parameter	Test Conditions	HY4004			Unit
			Min.	Typ.	Max.	
Dynamic Characteristics						
R_G	Gate Resistance	$V_{GS}=0V, V_{DS}=0V, F=1\text{MHz}$	-	0.8	-	Ω
C_{iss}	Input Capacitance	$V_{GS}=0V,$ $V_{DS}=25V,$ Frequency=1.0MHz	-	5700	-	pF
C_{oss}	Output Capacitance		-	1465	-	
C_{rss}	Reverse Transfer Capacitance		-	596	-	
$t_{d(ON)}$	Turn-on Delay Time	$V_{DD}=20V, R_G=6\Omega,$ $I_{DS}=104A, V_{GS}=10V,$	-	35	-	ns
T_r	Turn-on Rise Time		-	20	-	
$t_{d(OFF)}$	Turn-off Delay Time		-	45	-	
T_f	Turn-off Fall Time		-	62	-	
Gate Charge Characteristics						
Q_g	Total Gate Charge	$V_{DS}=32V, V_{GS}=10V,$ $I_{DS}=104A$	-	158	-	nC
Q_{gs}	Gate-Source Charge		-	30	-	
Q_{gd}	Gate-Drain Charge		-	66	-	

Note * : Pulse test ; pulse width $\leq 300\mu\text{s}$, duty cycle $\leq 2\%$.

Typical Operating Characteristics

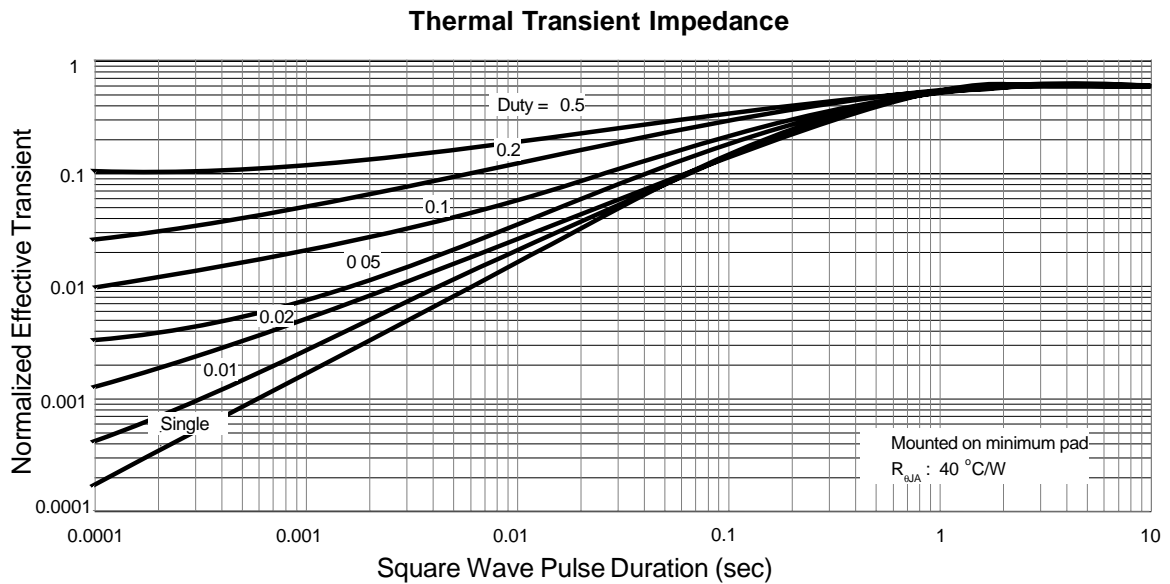
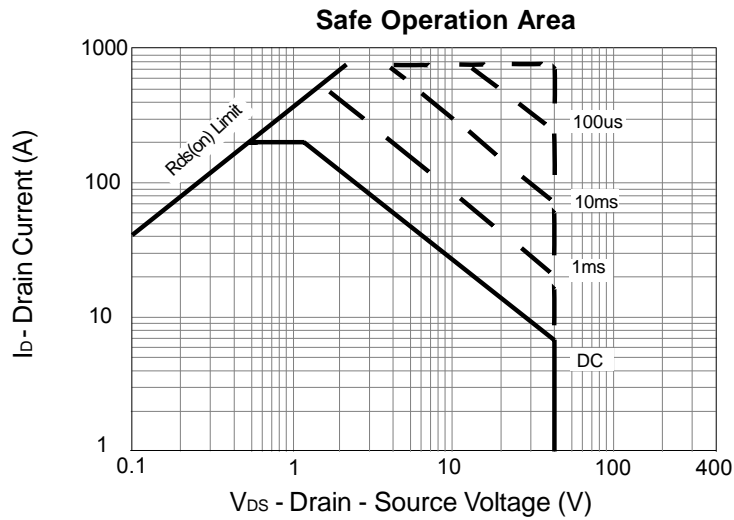
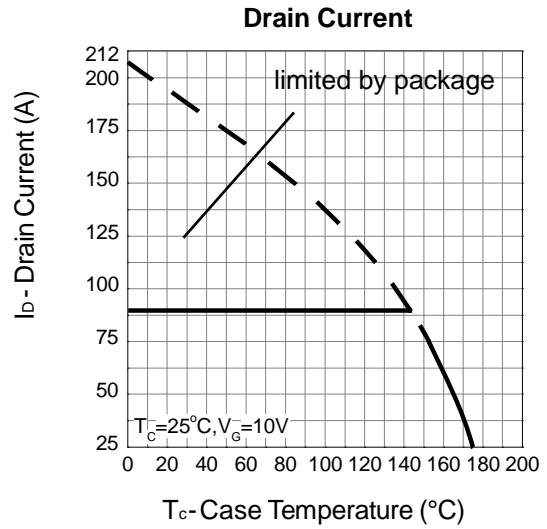
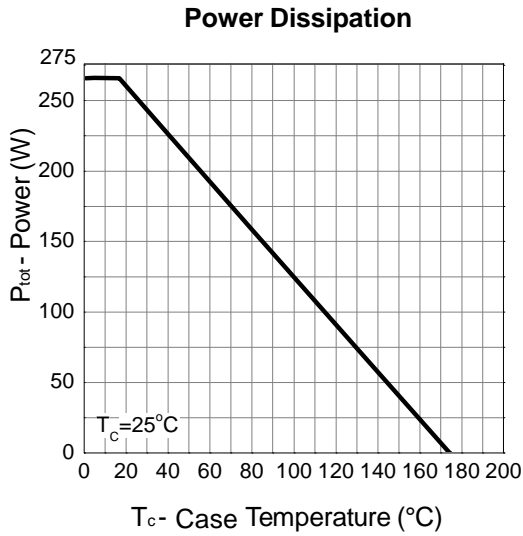

Typical Operating Characteristics (Cont.)

Output Characteristics

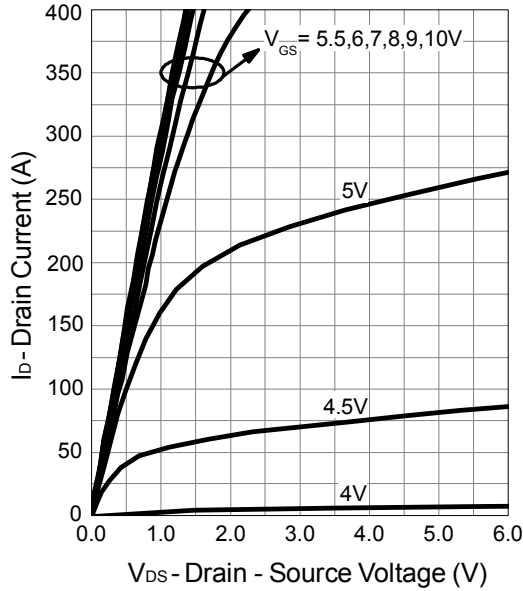

Drain-Source On Resistance

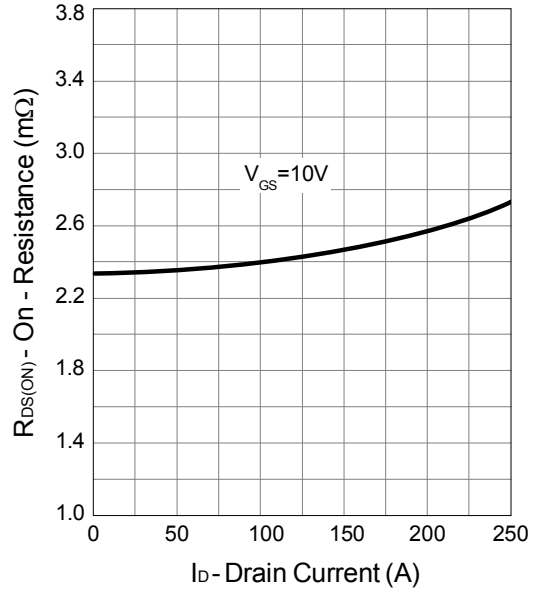

Gate-Source On Resistance

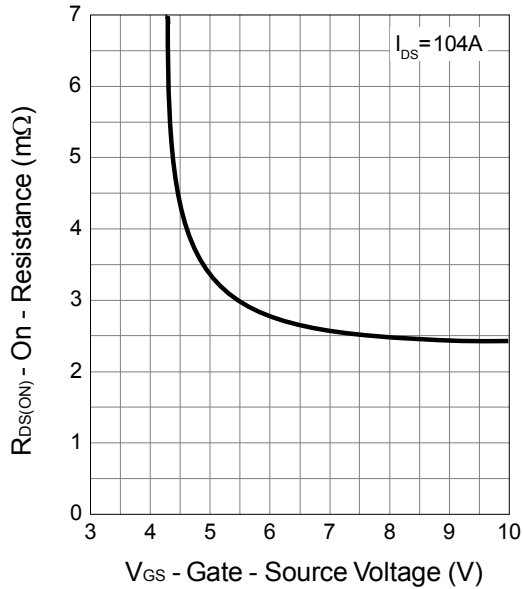

Gate Threshold Voltage

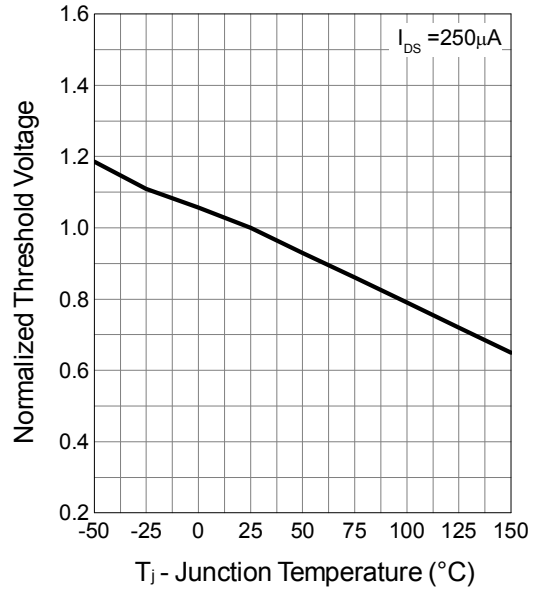

Typical Operating Characteristics (Cont.)

Drain-Source On Resistance

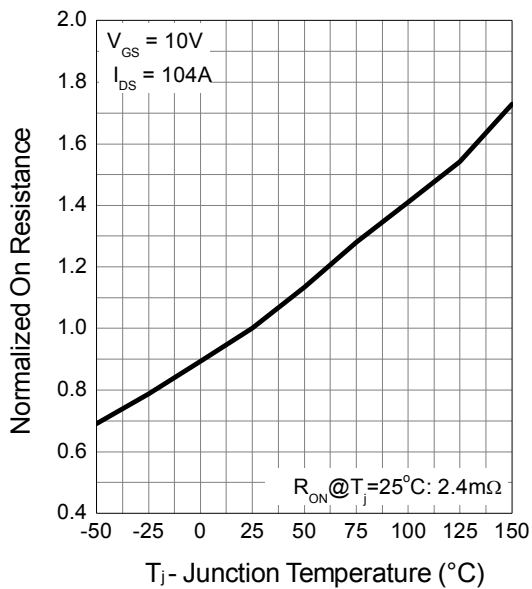

Source-Drain Diode Forward

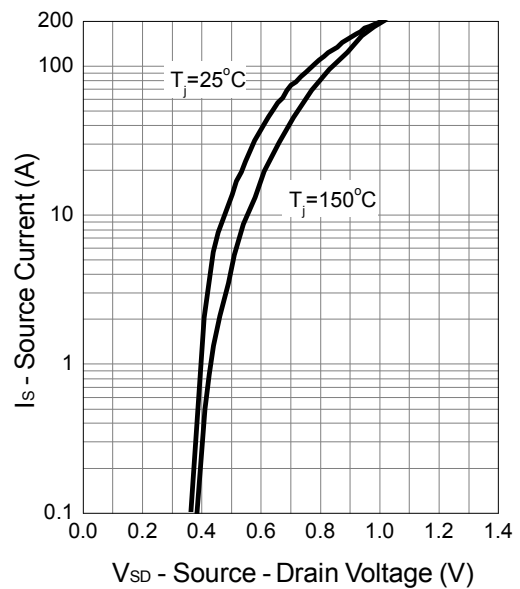

Capacitance

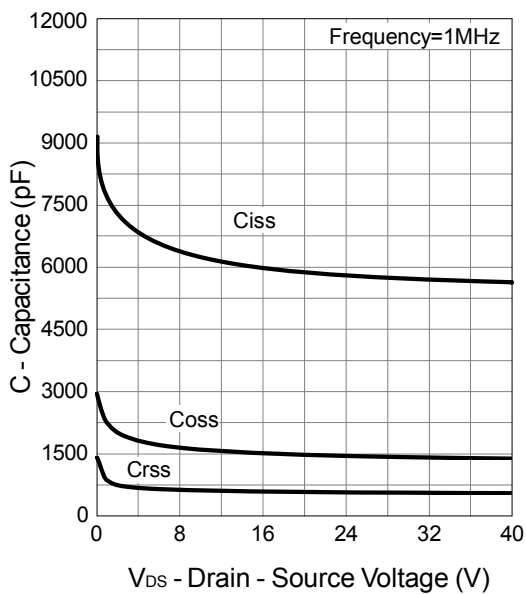

Gate Charge

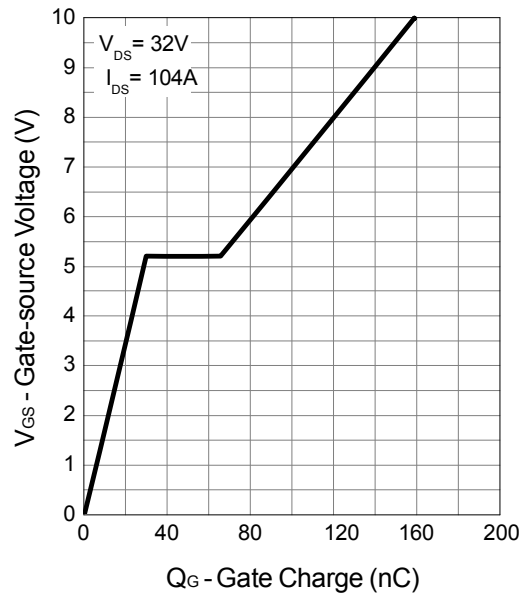

Avalanche Test Circuit and Waveforms

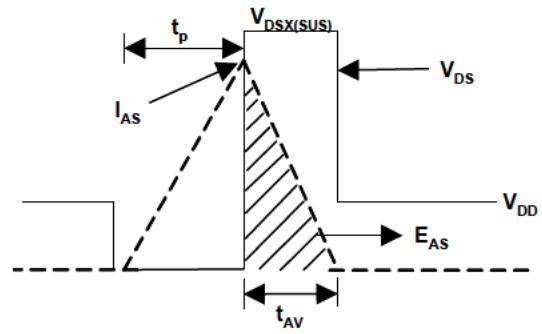
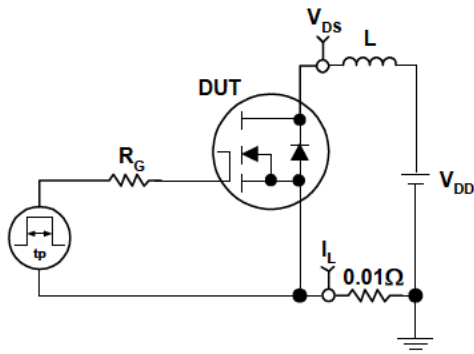

Avalanche Test Circuit and Waveforms



Package Information

TO-247-3L

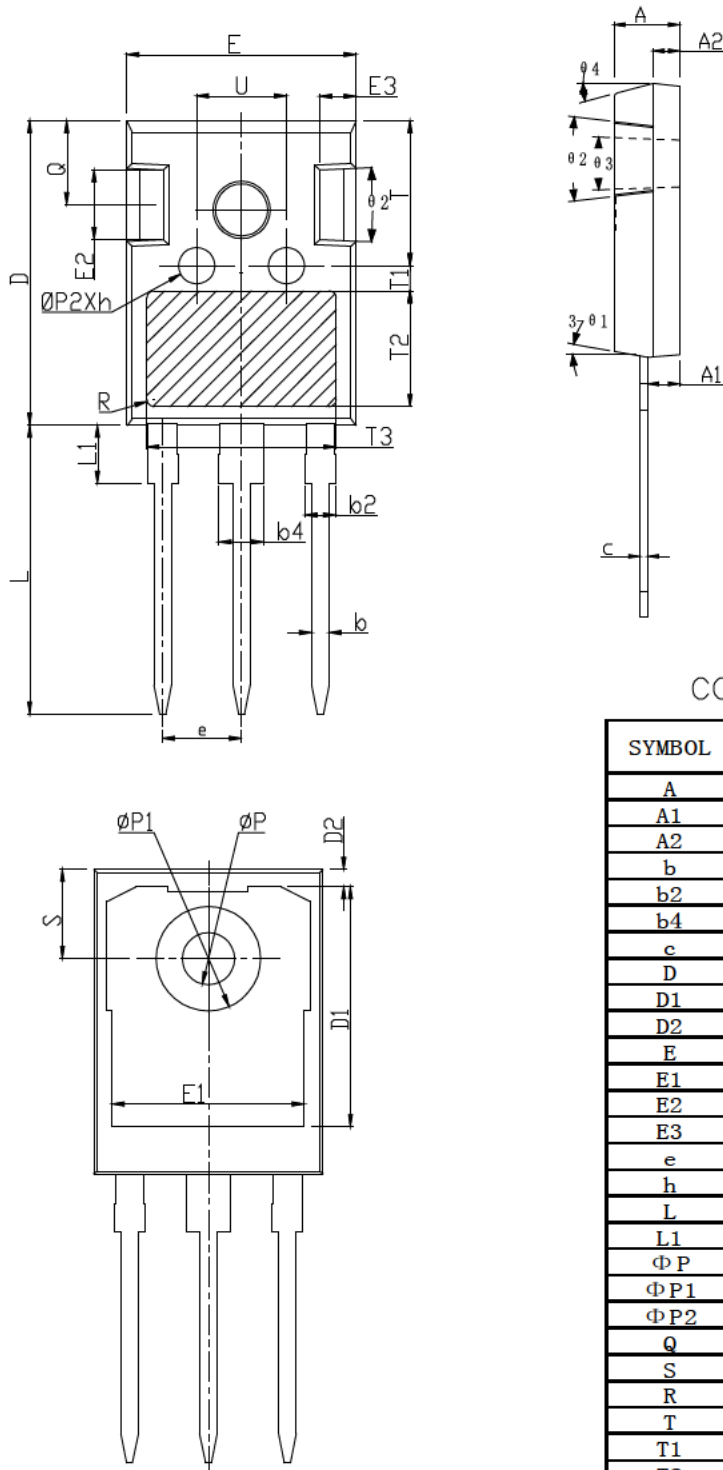

COMMON DIMENSIONS

SYMBOL	mm		
	MIN	NOM	MAX
A	4.90	5.00	5.10
A1	2.31	2.41	2.51
A2	1.90	2.00	2.10
b	1.16	1.21	1.26
b2	1.96	2.01	2.06
b4	2.96	3.01	3.06
c	0.59	0.61	0.66
D	20.90	21.00	21.10
D1	16.25	16.55	16.85
D2	1.05	1.20	1.35
E	15.70	15.80	15.90
E1	13.10	13.30	13.50
E2	4.90	5.00	5.10
E3	2.40	2.50	2.60
e	5.44BSC		
h	0.05	0.10	0.15
L	19.80	19.92	20.10
L1	-	-	4.30
ΦP	3.50	3.60	3.70
ΦP1	-	-	7.30
ΦP2	2.40	2.50	2.60
Q	5.60	5.80	6.00
S	6.15BSC		
R	0.50REF		
T	9.80	-	10.20
T1	1.65REF		
T2	8.00REF		
T3	12.80REF		
U	6.00	-	6.40
Ø1	6°	7°	8°
Ø2	4°	5°	6°
Ø3	1°	-	1.5°
Ø4	14°	15°	16°

TO-3P-3L

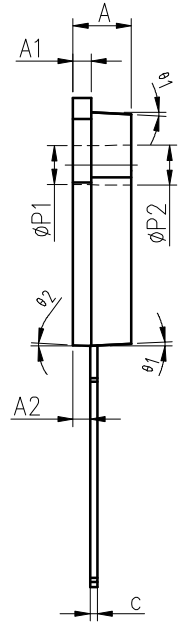
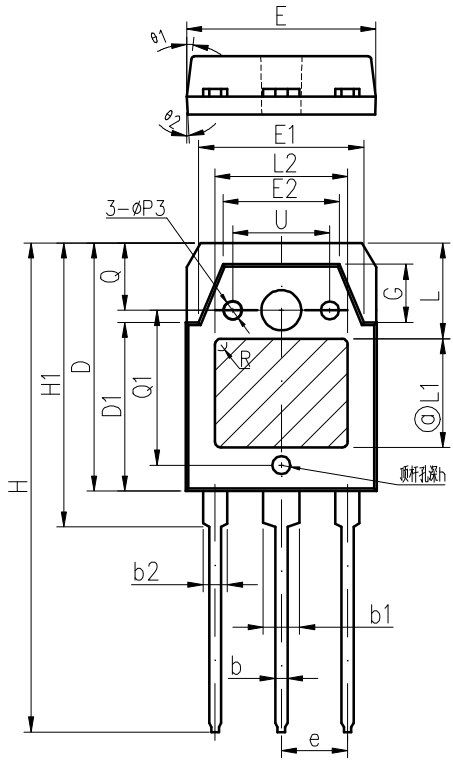

COMMON DIMENSIONS

SYMBOL	mm		
	MIN	NOM	MAX
A	4.60	4.80	5.00
A1	1.40	1.50	1.60
A2	1.33	1.38	1.43
b	0.80	1.00	1.20
b1	2.80	3.00	3.20
b2	1.80	2.00	2.20
c	0.50	0.60	0.70
D	19.75	19.90	20.05
D1	13.70	13.90	14.10
D2		12.90	REF
E	15.40	15.60	15.80
E1	13.40	13.60	13.80
E2	9.40	9.60	9.80
e		5.45	TYP
G	4.60	4.80	5.00
H	40.30	40.50	40.70
H1	23.20	23.40	23.60
h	0.05	0.10	0.15
L		7.40	TYP
L1		9.00	TYP
L2		11.00	TYP
L3		1.00	REF
P	6.90	7.00	7.10
P1		3.20	REF
P2		3.50	REF
P3	1.40	1.50	1.60
R		0.50	REF
Q		5.00	REF
Q1	12.56	12.76	12.96
U	7.8	8	8.2
θ1	5°	7°	9°
θ2	1°	3°	5°
θ3		60°	REF

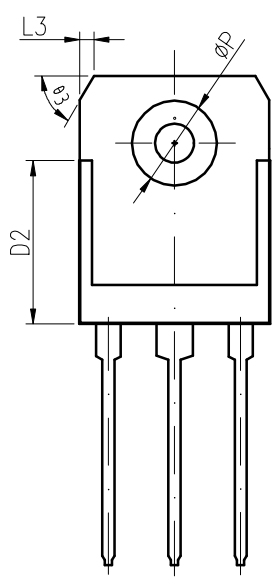

Devices Per Unit

Package Type	Unit	Quantity
TO-247-3L	Tube	30
TO-3P-3L	Tube	30

Classification Profile

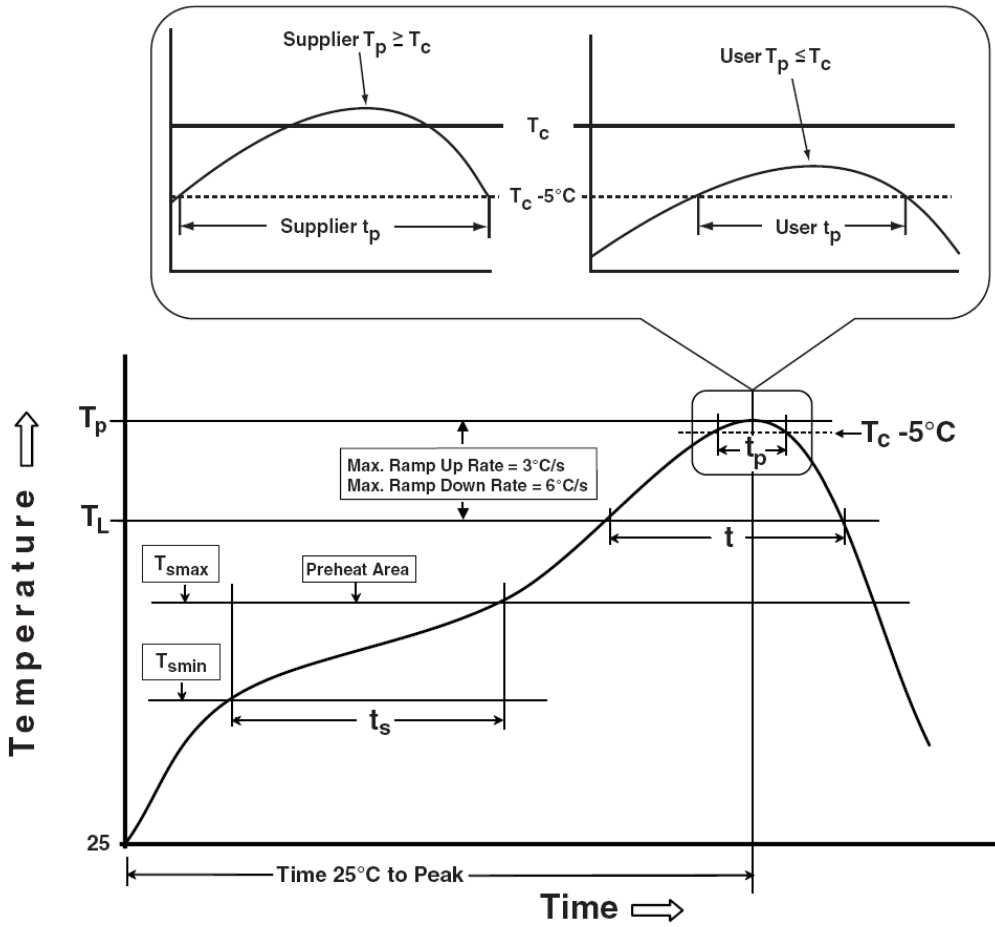

Classification Reflow Profiles

Profile Feature	Sn-Pb Eutectic Assembly	Pb-Free Assembly
Preheat & Soak		
Temperature min (T_{smin})	100 °C	150 °C
Temperature max (T_{smax})	150 °C	200 °C
Time (T_{smin} to T_{smax}) (t_s)	60-120 seconds	60-120 seconds
Average ramp-up rate (T_{smax} to T_p)	3 °C/second max.	3°C/second max.
Liquidous temperature (T_L)	183 °C	217 °C
Time at liquidous (t_L)	60-150 seconds	60-150 seconds
Peak package body Temperature (T_p)*	See Classification Temp in table 1	See Classification Temp in table 2
Time (t_p)** within 5°C of the specified classification temperature (T_c)	20** seconds	30** seconds
Average ramp-down rate (T_p to T_{smax})	6 °C/second max.	6 °C/second max.
Time 25°C to peak temperature	6 minutes max.	8 minutes max.
* Tolerance for peak profile Temperature (T_p) is defined as a supplier minimum and a user maximum. ** Tolerance for time at peak profile temperature (t_p) is defined as a supplier minimum and a user maximum.		

Table 1. SnPb Eutectic Process – Classification Temperatures (T_c)

Package Thickness	Volume mm ³ <350	Volume mm ³ ≥350
<2.5 mm	235 °C	220 °C
≥2.5 mm	220 °C	220 °C

Table 2. Pb-free Process – Classification Temperatures (T_c)

Package Thickness	Volume mm ³ <350	Volume mm ³ 350-2000	Volume mm ³ >2000
<1.6 mm	260 °C	260 °C	260 °C
1.6 mm – 2.5 mm	260 °C	250 °C	245 °C
≥2.5 mm	250 °C	245 °C	245 °C

Reliability Test Program

Test item	Method	Description
SOLDERABILITY	JESD-22, B102	5 Sec, 245°C
HOLT	JESD-22, A108	1000 Hrs, Bias @ 125°C
PCT	JESD-22, A102	168 Hrs, 100%RH, 2atm, 121°C
TCT	JESD-22, A104	500 Cycles, -65°C~150°C