

## N-Channel Enhancement Mode MOSFET

### Features

- 125V/250A  
 $R_{DS(ON)} = 3.8\text{ m}\Omega$  (typ.) @  $V_{GS} = 10\text{V}$
- Avalanche Rated
- Reliable and Rugged
- Lead Free and Green Devices Available (RoHS Compliant)

### Pin Description

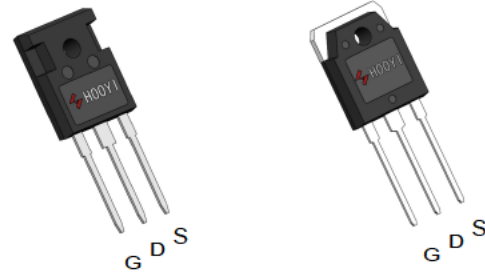

TO-247-3L



TO-3P-3L

### Applications

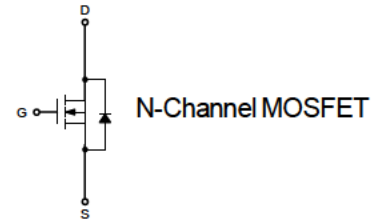
- Power Management for Inverter Systems.



### Ordering and Marking Information

 <b>W</b>  <b>A</b> <b>HY4512</b> <b>HY4512</b> YYXXJWW G    YYXXJWW G	<b>Package Code</b> W : TO-247-3L     A : TO-3P-3L  <b>Date Code</b> <b>Assembly Material</b> YYXX WW     G : Lead Free Device
--	--

**Note:** HOOYI lead-free products contain molding compounds/die attach materials and 100% matte tin plate termination finish; which are fully compliant with RoHS. HOOYI lead-free products meet or exceed the lead-free requirements of IPC/JEDEC J-STD-020D for MSL classification at lead-free peak reflow temperature. HOOYI defines "Green" to mean lead-free (RoHS compliant) and halogen free (Br or Cl does not exceed 900ppm by weight in homogeneous material and total of Br and Cl does not exceed 1500ppm by weight).

HOOYI reserves the right to make changes to improve reliability or manufacturability without notice, and advise customers to obtain the latest version of relevant information to verify before placing orders.

## Absolute Maximum Ratings

Symbol	Parameter		Rating	Unit
<b>Common Ratings</b> ( $T_C=25^\circ\text{C}$ Unless Otherwise Noted)				
$V_{DSS}$	Drain-Source Voltage		125	V
$V_{GSS}$	Gate-Source Voltage		$\pm 25$	
$T_J$	Maximum Junction Temperature		175	$^\circ\text{C}$
$T_{STG}$	Storage Temperature Range		-55 to 175	$^\circ\text{C}$
$I_S$	Diode Continuous Forward Current	$T_C=25^\circ\text{C}$	250	A
<b>Mounted on Large Heat Sink</b>				
$I_{DM}$	Pulsed Drain Current *	$T_C=25^\circ\text{C}$	900**	A
$I_D$	Continuous Drain Current	$T_C=25^\circ\text{C}$	250	A
		$T_C=100^\circ\text{C}$	162	
$P_D$	Maximum Power Dissipation	$T_C=25^\circ\text{C}$	469	W
		$T_C=100^\circ\text{C}$	234	
$R_{\theta JC}$	Thermal Resistance-Junction to Case		0.32	$^\circ\text{C/W}$
$R_{\theta JA}$	Thermal Resistance-Junction to Ambient		40	
<b>Avalanche Ratings</b>				
$E_{AS}$	Avalanche Energy, Single Pulsed	$L=0.5\text{mH}$	1150***	mJ

Note : \* Repetitive rating ; pulse width limited by junction temperature

\*\* Drain current is limited by junction temperature

\*\*\*  $V_D=100\text{V}$

## Electrical Characteristics ( $T_C = 25^\circ\text{C}$ Unless Otherwise Noted)

Symbol	Parameter	Test Conditions	HY4512			Unit
			Min.	Typ.	Max.	
<b>Static Characteristics</b>						
$BV_{DSS}$	Drain-Source Breakdown Voltage	$V_{GS}=0\text{V}, I_{DS}=250\mu\text{A}$	125	-	-	V
$I_{DSS}$	Zero Gate Voltage Drain Current	$V_{DS}=125\text{V}, V_{GS}=0\text{V}$ $T_J=85^\circ\text{C}$	-	-	1	$\mu\text{A}$
			-	-	10	
$V_{GS(th)}$	Gate Threshold Voltage	$V_{DS}=V_{GS}, I_{DS}=250\mu\text{A}$	2	3	4	V
$I_{GSS}$	Gate Leakage Current	$V_{GS}=\pm 25\text{V}, V_{DS}=0\text{V}$	-	-	$\pm 100$	nA
$R_{DS(ON)*}$	Drain-Source On-state Resistance	$V_{GS}=10\text{V}, I_{DS}=125\text{A}$	-	3.8	4.8	$\text{m}\Omega$
<b>Diode Characteristics</b>						
$V_{SD}^*$	Diode Forward Voltage	$I_{SD}=125\text{A}, V_{GS}=0\text{V}$	-	0.8	1.3	V
$t_{rr}$	Reverse Recovery Time	$I_{SD}=125\text{A}, dI_{SD}/dt=100\text{A}/\mu\text{s}$	-	68	-	ns
$Q_{rr}$	Reverse Recovery Charge		-	120	-	nC

**Electrical Characteristics (Cont.)** ( $T_c = 25^\circ\text{C}$  Unless Otherwise Noted)

Symbol	Parameter	Test Conditions	HY4512			Unit
			Min.	Typ.	Max.	
<b>Dynamic Characteristics</b>						
$R_G$	Gate Resistance	$V_{GS}=0V, V_{DS}=0V, F=1\text{MHz}$	-	0.6	-	$\Omega$
$C_{iss}$	Input Capacitance	$V_{GS}=0V,$ $V_{DS}=25V,$ Frequency=1.0MHz	-	11132	-	pF
$C_{oss}$	Output Capacitance		-	1152	-	
$C_{rss}$	Reverse Transfer Capacitance		-	689	-	
$t_{d(ON)}$	Turn-on Delay Time	$V_{DD}=62.5V, R_G=6\Omega,$ $I_{DS}=125A, V_{GS}=10V,$	-	52	-	ns
$T_r$	Turn-on Rise Time		-	47	-	
$t_{d(OFF)}$	Turn-off Delay Time		-	118	-	
$T_f$	Turn-off Fall Time		-	90	-	
<b>Gate Charge Characteristics</b>						
$Q_g$	Total Gate Charge	$V_{DS}=100V, V_{GS}=10V,$ $I_{DS}=125$	-	278	-	nC
$Q_{gs}$	Gate-Source Charge		-	40	-	
$Q_{gd}$	Gate-Drain Charge		-	93	-	

Note \* : Pulse test ; pulse width  $\leq 300\mu\text{s}$ , duty cycle  $\leq 2\%$ .

## Typical Operating Characteristics

**Power Dissipation**

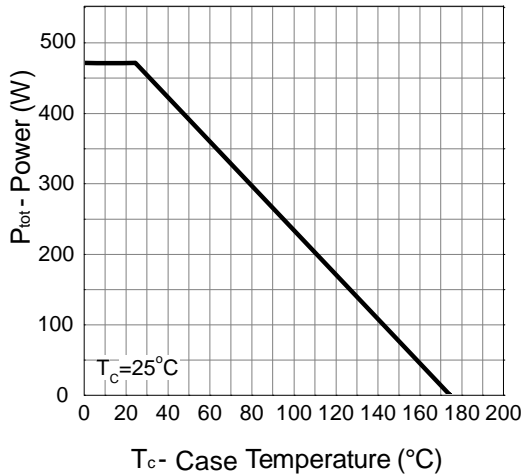

**Drain Current**

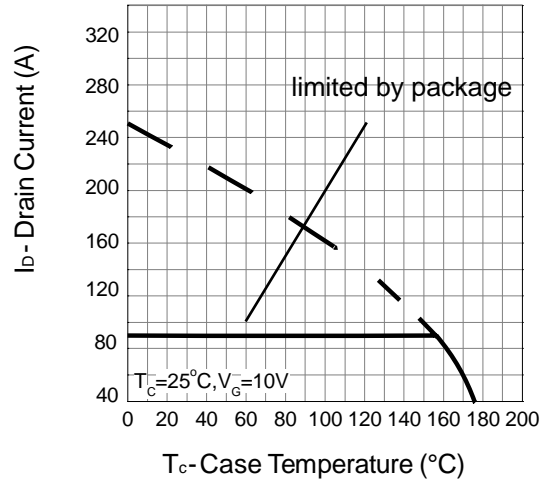

**Safe Operation Area**

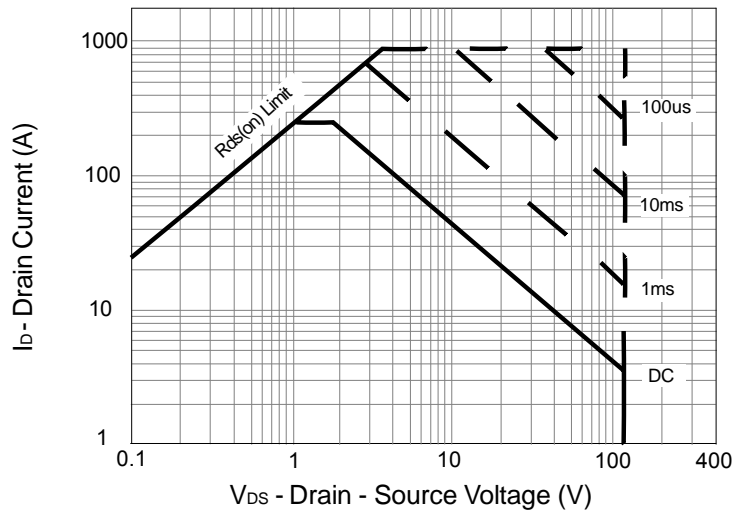

**Thermal Transient Impedance**

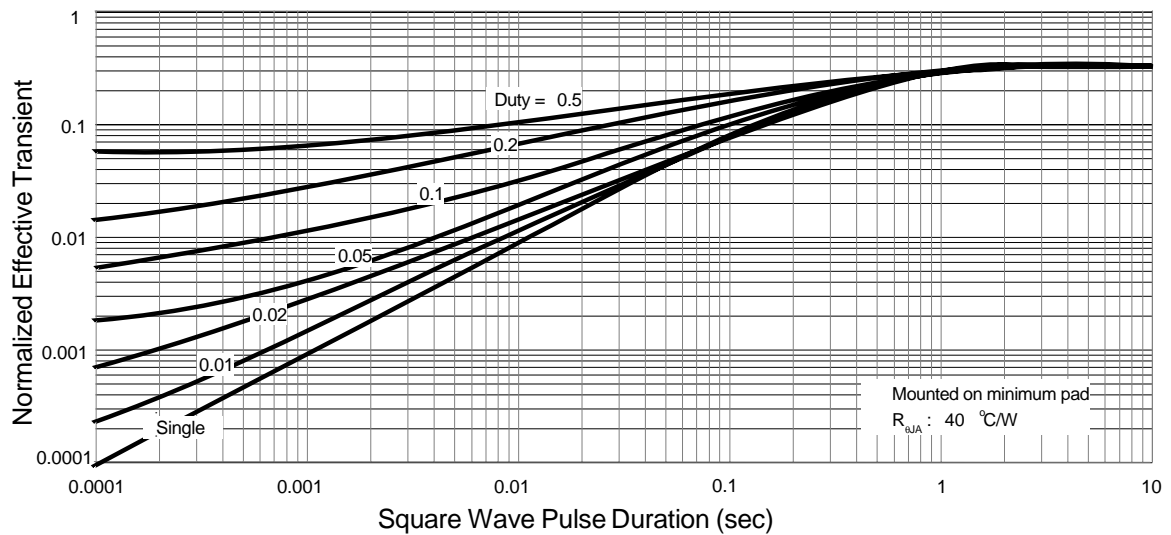

**Typical Operating Characteristics (Cont.)**

**Output Characteristics**

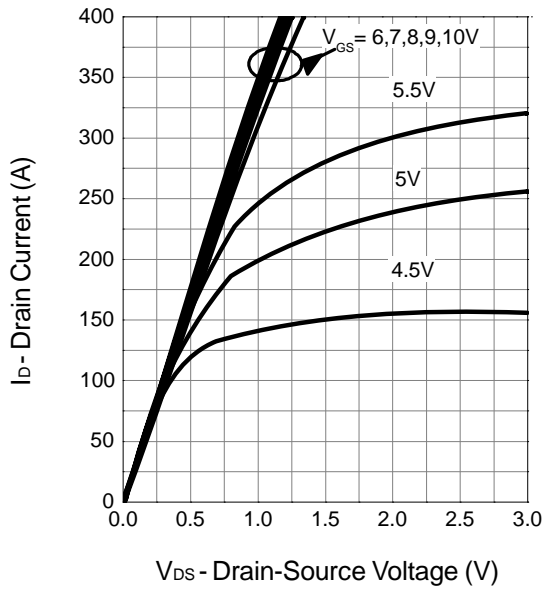

**Drain-Source On Resistance**

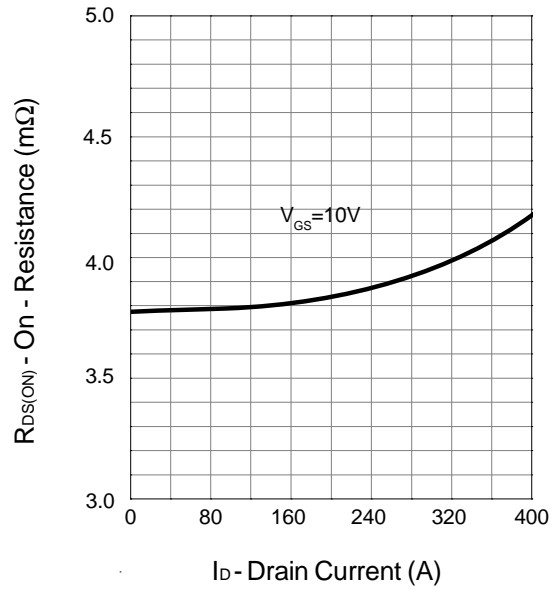

**Drain-Source On Resistance**

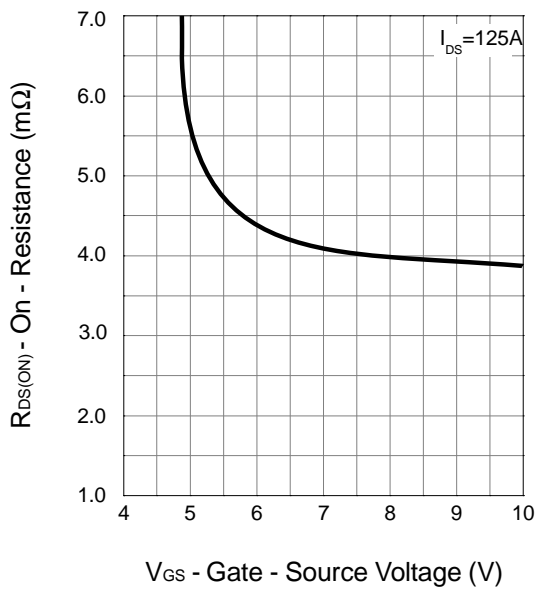

**Gate Threshold Voltage**

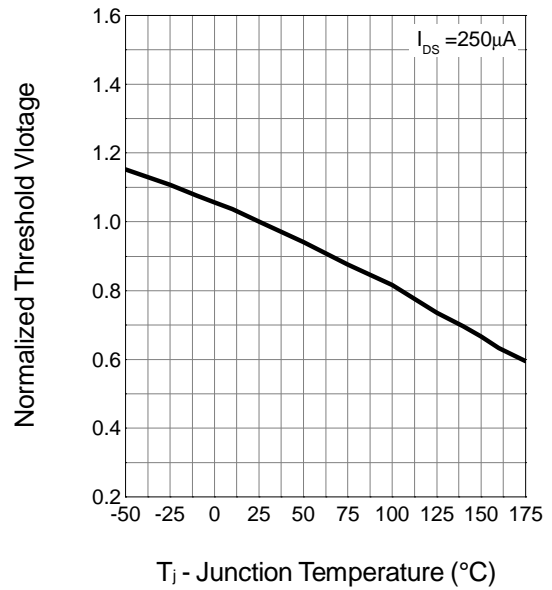

**Typical Operating Characteristics (Cont.)**

**Drain-Source On Resistance**

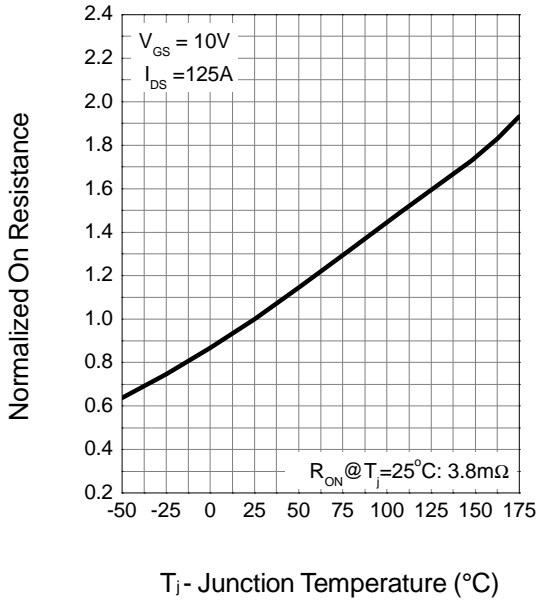

**Source-Drain Diode Forward**

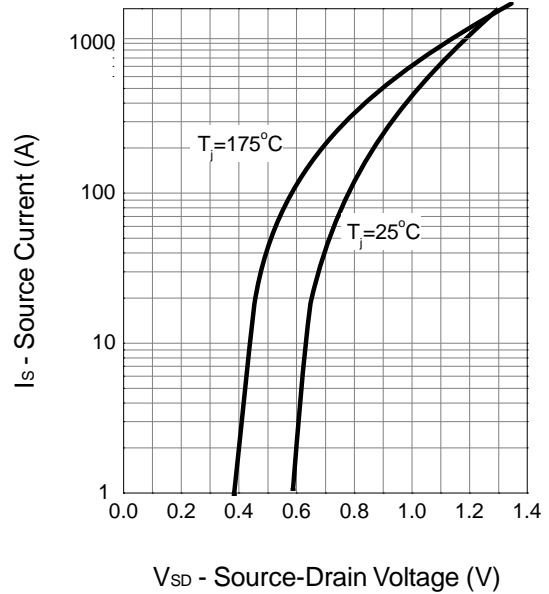

**Capacitance**

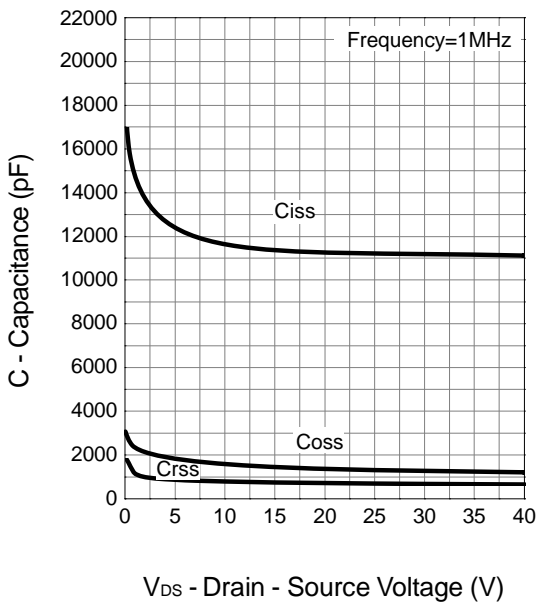

**Gate Charge**

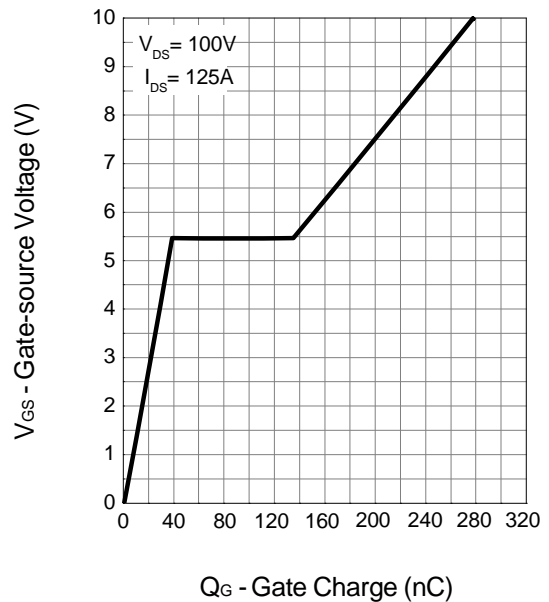

## Avalanche Test Circuit and Waveforms

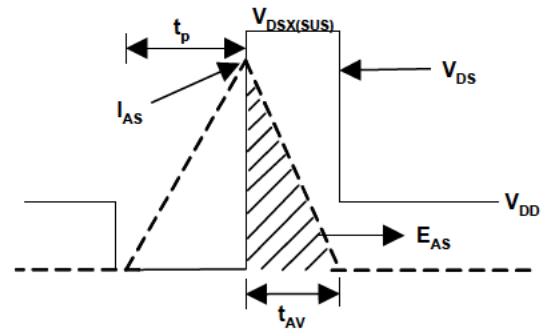
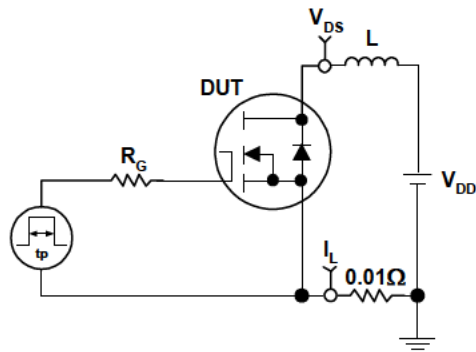

## Avalanche Test Circuit and Waveforms

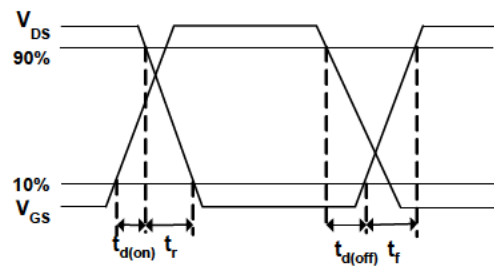
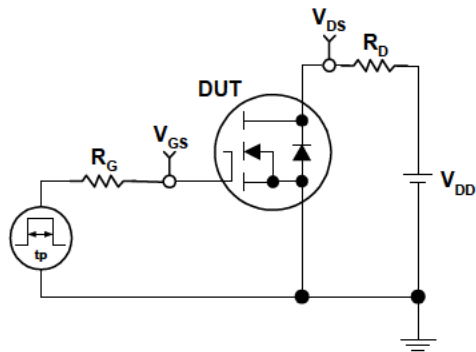

**Package Information**

**TO-247-3L**

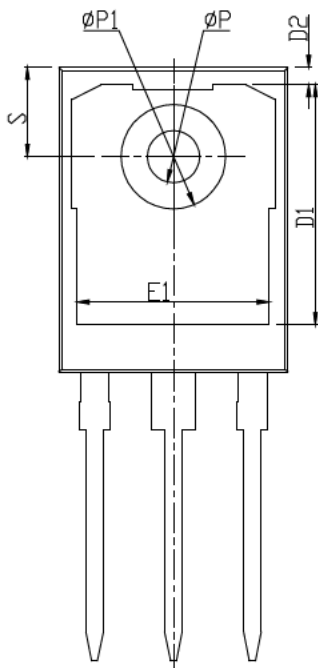
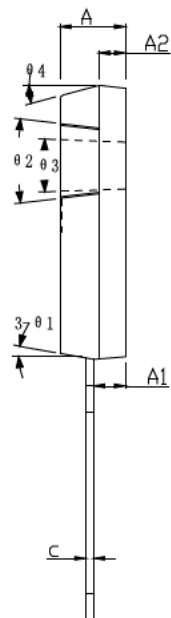
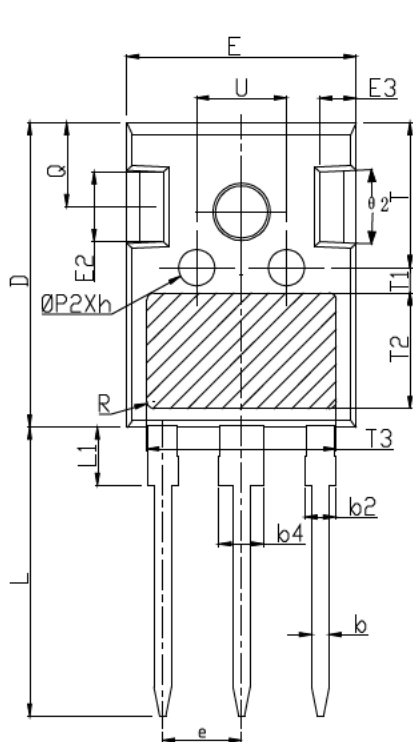

COMMON DIMENSIONS

SYMBOL	mm		
	MIN	NOM	MAX
A	4.90	5.00	5.10
A1	2.31	2.41	2.51
A2	1.90	2.00	2.10
b	1.16	1.21	1.26
b2	1.96	2.01	2.06
b4	2.96	3.01	3.06
c	0.59	0.61	0.66
D	20.90	21.00	21.10
D1	16.25	16.55	16.85
D2	1.05	1.20	1.35
E	15.70	15.80	15.90
E1	13.10	13.30	13.50
E2	4.90	5.00	5.10
E3	2.40	2.50	2.60
e	5.44BSC		
h	0.05	0.10	0.15
L	19.80	19.92	20.10
L1	-	-	4.30
ΦP	3.50	3.60	3.70
ΦP1	-	-	7.30
ΦP2	2.40	2.50	2.60
Q	5.60	5.80	6.00
S	6.15BSC		
R	0.50REF		
T	9.80	-	10.20
T1	1.65REF		
T2	8.00REF		
T3	12.80REF		
U	6.00	-	6.40
Ø 1	6°	7°	8°
Ø 2	4°	5°	6°
Ø 3	1°	-	1.5°
Ø 4	14°	15°	16°



**TO-3P-3L**

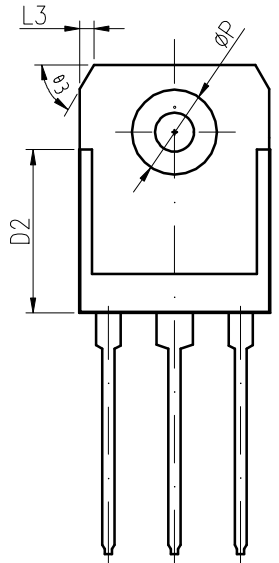
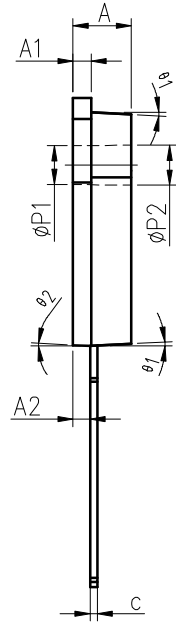
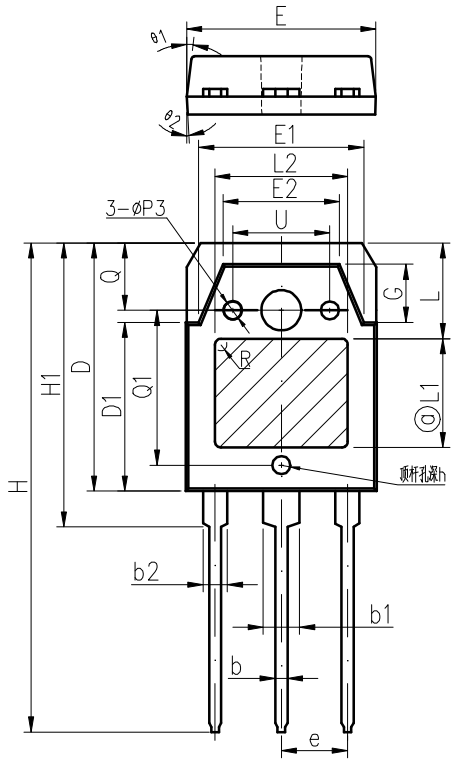

**COMMON DIMENSIONS**

SYMBOL	mm		
	MIN	NOM	MAX
A	4.60	4.80	5.00
A1	1.40	1.50	1.60
A2	1.33	1.38	1.43
b	0.80	1.00	1.20
b1	2.80	3.00	3.20
b2	1.80	2.00	2.20
c	0.50	0.60	0.70
D	19.75	19.90	20.05
D1	13.70	13.90	14.10
D2		12.90	REF
E	15.40	15.60	15.80
E1	13.40	13.60	13.80
E2	9.40	9.60	9.80
e		5.45	TYP
G	4.60	4.80	5.00
H	40.30	40.50	40.70
H1	23.20	23.40	23.60
h	0.05	0.10	0.15
L		7.40	TYP
L1		9.00	TYP
L2		11.00	TYP
L3		1.00	REF
P	6.90	7.00	7.10
P1		3.20	REF
P2		3.50	REF
P3	1.40	1.50	1.60
R		0.50	REF
Q		5.00	REF
Q1	12.56	12.76	12.96
U	7.8	8	8.2
θ1	5°	7°	9°
θ2	1°	3°	5°
θ3		60°	REF

**Devices Per Unit**

Package Type	Unit	Quantity
TO-247-3L	Tube	30
TO-3P-3L	Tube	30

**Classification Profile**

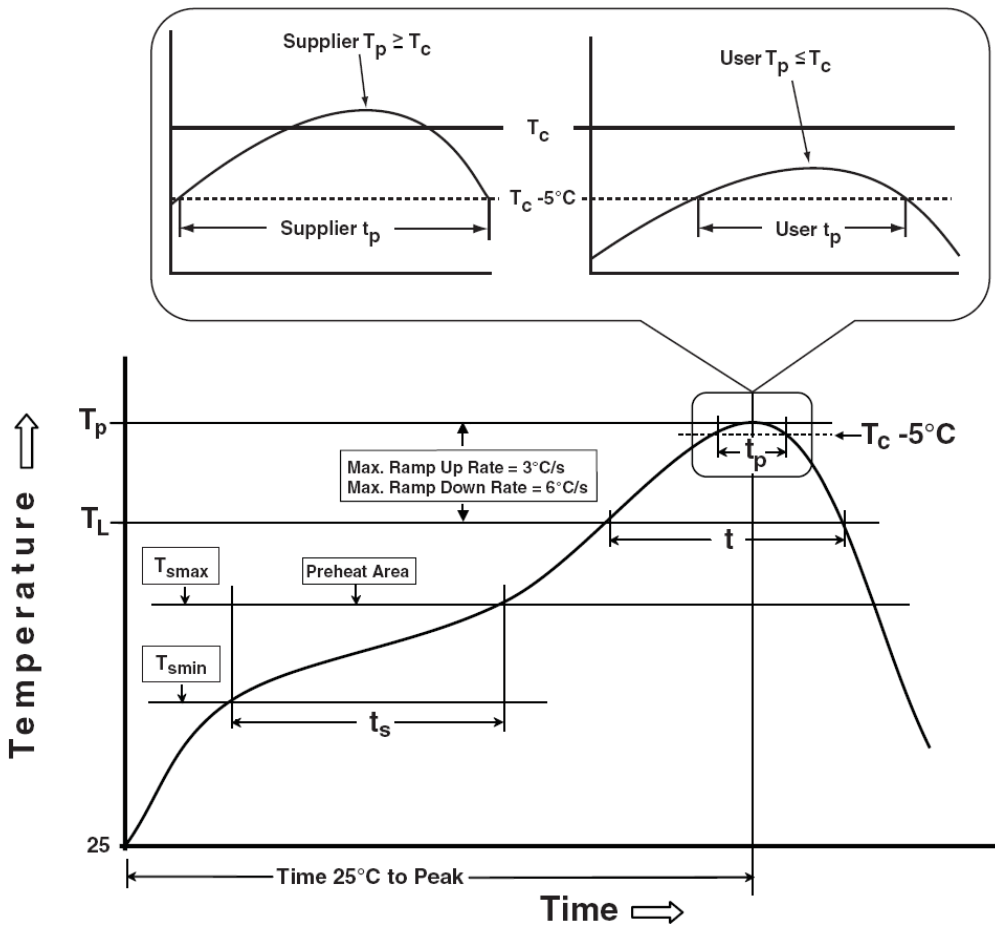

## Classification Reflow Profiles

Profile Feature	Sn-Pb Eutectic Assembly	Pb-Free Assembly
<b>Preheat &amp; Soak</b>		
Temperature min ( $T_{smin}$ )	100 °C	150 °C
Temperature max ( $T_{smax}$ )	150 °C	200 °C
Time ( $T_{smin}$ to $T_{smax}$ ) ( $t_s$ )	60-120 seconds	60-120 seconds
Average ramp-up rate ( $T_{smax}$ to $T_p$ )	3 °C/second max.	3°C/second max.
Liquidous temperature ( $T_L$ )	183 °C	217 °C
Time at liquidous ( $t_L$ )	60-150 seconds	60-150 seconds
Peak package body Temperature ( $T_p$ )*	See Classification Temp in table 1	See Classification Temp in table 2
Time ( $t_p$ )** within 5°C of the specified classification temperature ( $T_c$ )	20** seconds	30** seconds
Average ramp-down rate ( $T_p$ to $T_{smax}$ )	6 °C/second max.	6 °C/second max.
Time 25°C to peak temperature	6 minutes max.	8 minutes max.
* Tolerance for peak profile Temperature ( $T_p$ ) is defined as a supplier minimum and a user maximum.		
** Tolerance for time at peak profile temperature ( $t_p$ ) is defined as a supplier minimum and a user maximum.		

Table 1. SnPb Eutectic Process – Classification Temperatures ( $T_c$ )

Package Thickness	Volume mm <sup>3</sup> <350	Volume mm <sup>3</sup> ≥350
<2.5 mm	235 °C	220 °C
≥2.5 mm	220 °C	220 °C

Table 2. Pb-free Process – Classification Temperatures ( $T_c$ )

Package Thickness	Volume mm <sup>3</sup> <350	Volume mm <sup>3</sup> 350-2000	Volume mm <sup>3</sup> >2000
<1.6 mm	260 °C	260 °C	260 °C
1.6 mm – 2.5 mm	260 °C	250 °C	245 °C
≥2.5 mm	250 °C	245 °C	245 °C

## Reliability Test Program

Test item	Method	Description
SOLDERABILITY	JESD-22, B102	5 Sec, 245°C
HOLT	JESD-22, A108	1000 Hrs, Bias @ 125°C
PCT	JESD-22, A102	168 Hrs, 100%RH, 2atm, 121°C
TCT	JESD-22, A104	500 Cycles, -65°C~150°C